

ICON
Shelter Systems Inc

AN ICONIC
SHELTER
EXPERIENCE





AN ICONIC SHELTER EXPERIENCE



VOLUME IV

“The art of architecture studies not structure in itself, but the effect of structure on the human spirit.” Geoffrey Scott

- 2 OUR STORY**
- 3 THE ICON PROCESS**
- 5 QUALITY**
- 6 FEATURED PROJECTS**
 - Royal Oak | Grandville | Pearl Park | Elk Grove | Las Vegas Art District | Piscataway | Mackinac Island
- 20 STYLE GUIDES**
 - Structural Art | Ironworks | Craftsman | Filtered Light Panels | Swings | LiveShade | DSA Shelters
- 34 INDUSTRY STANDARD SHELTERS**
 - Squares | Hexagons | Octagons | Rectangle Gables | Rectangle Hips | Barrel Vaults | Intervals | Stretched Shelters | Dual Slope Shelters | Mono-Slopes | Mini-Shelters
- 47 OTHER STRUCTURES**
 - Bandshells | Partial Shade/Arbors | Entry Arches | Pedestrian Bridges | Mailbox Shelters | Clock Towers | Umbrella Shelters | Message Shelters | Fabric Shades
- 59 PICNIC TABLE CAPACITIES**
- 60 WARRANTY**
- 61 CUSTOMIZATIONS**
 - Weathervanes | Cupolas | Handrails and Ornamentation | Clocks | Emblems and Signs | Steel Roof Colors | Steel Frame Finishings | Powder Coat Colors

We Believe in Leadership by Innovation

ICON SHELTER SYSTEMS, INC. WAS STARTED IN 2004 BY A TEAM OF CREATIVE INDUSTRY EXPERTS IN HOLLAND, MI. WE BELIEVE IN LEADERSHIP BY INNOVATION. OUR ACCOMPLISHED EMPLOYEES HAVE COLLABORATED WITH RENOWNED DESIGN PROFESSIONALS TO TURN THEIR VISIONS INTO OUTDOOR REALITIES ALL OVER THE GLOBE.

Our commitment to customer relationships, personalized design services, and in-house engineering and manufacturing processes empower us to transform our customers' thoughts, dreams, and ideas into the most ICONIC shelter experiences in the world.



THE ICON PROCESS

1. Consultation

The first stage of our process begins with you... and deciding to fill a negative space with a creative and aesthetically pleasing statement to bring people together. Our ICON team of design specialists will schedule a consultation to meet with you one on one to curate and hone in on your goals, vision, and dreams for your structure.

2. Design Creation

Next comes the preliminary calculations and sketches. We connect the design features with engineering experts to develop a custom structure every time. Our engineers handle everything in-house from concept, to stamped engineered drawings to final project. Our world-class facility in Holland, Michigan, forges the steel which is finished with durable powder coating before being transported to its final site.

3. Installation

All ICON structures are pre-fabricated and pre-engineered under precise factory specifications, meaning when the shelter arrives onsite it is ready for an easy installation.

4. Enjoyment

Lastly, sit back and celebrate the rewards of transforming a space into a destination that brings people together. Whether it is a family picnic, community meeting, watching an outdoor performance or simply enjoying the outdoors, ICON is here to help you create lifetime memories.

ICON offers complete customization, from idea formulation to installation. We work hand in hand with professionals all over the country who design, build, and maintain public spaces. We strive to combine shade and art into striking structures that will stand the test of time.



DSA Structures

LET ICON HELP ENSURE YOUR STRUCTURE MEETS THE LATEST REGULATIONS AVAILABLE.

ICON is pleased to offer pre-approved and custom DSA (Division of the State Architect) shelters that comply with all structural and safety codes in the state of California.

Continuing Education

ICON IS PLEASED TO PARTNER WITH AECDAILY TO PROVIDE CONTINUING EDUCATION UNITS (CEUS).

The self-paced course titled *Pre-Engineered/Manufactured Shelters: Standard and Custom Solutions for Outdoor Spaces* can be accessed by scanning the below QR code and watching the course at your leisure.



After the course, you will be able to:

1. Explain how outdoor shelters provide protection from the elements and add visual interest to outdoor spaces.
2. Describe how advances in shelter design are changing the recreational landscape.
3. Discuss current capabilities in shelter design.
4. Understand the difference between pre-engineered and site-built shelters.

The course is both AIA and LA CES approved and provides 1.25 credits.



Quality

ICON'S MANUFACTURING PROCESSES DELIVER STATE-OF-THE-ART QUALITY AND CRAFTSMANSHIP.

We take pride in our work every step along the way so that you can be confident your shelter will be enjoyed for years to come.

At ICON we understand that all projects are not the same, that's why we provide a variation of frame finishes to meet your specific needs. Choose from ICON's Premier Choice, Prime Painted, or Hot Dip Galvanized finishes to meet your specific needs.



Other options include Prime Painted:

- Steel is cleaned removing loose mill scale, rust, paint, and other detrimental foreign matter.
- The cleaned steel will then be prime painted with quick dry, lead and chromate free alkyd primed.
- Finish painting is completed in the field by installers.

Or Hot Dipped Galvanized:

- Steel is cleaned removing loose mill scale, rust, paint, and other detrimental foreign matter.
- The cleaned steel is then immersed in a bath of molten zinc metal.
- The resulting galvanized steel requires no maintenance for decades.

ICON's Premier Choice includes a combination of liquid epoxy primer and two coats of TGIC polyester powder coating.

- Steel is shot-blasted to meet SSPC-SP10 specification (nearly white condition), removing all oil residue, mill scale, weld spatter, and slag.
- The steel is then immersed in zinc phosphate completing an 8-stage pre-treatment process.
- Next, liquid epoxy is electrostatically applied and coated to a uniform 0.7-0.9 mils. This **E-Coat Powdercoat** provides total encapsulation which prevents rusting.
- Lastly, a double coat of TGIC polyester powder is applied. One coat of color followed by one clear coating for a final finish that is 8-12 mils thick.

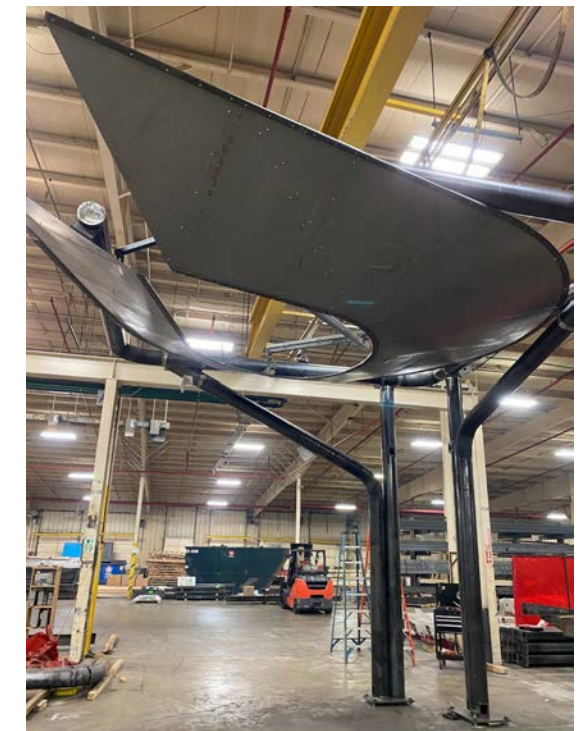

Centennial Commons Downtown Park Royal Oak, Michigan

FEATURED PROJECT



SWIRLING ARCS CREATE A
COLORFUL FOCAL POINT TO
A PUBLIC LIBRARY.

The Royal Oak Public Library used the Red Oak leaf for inspiration for the ideation of their new custom terrace. ICON worked with a design task force to develop swirling arcs of lime green to create a colorful overhead canopy, featuring uplighting to enhance the appearance after dark. The result is a perfect space where library patrons can gather, take a break, and enjoy the outdoors.

Grandville Farmers Market | Grandville, MI

FEATURED PROJECT

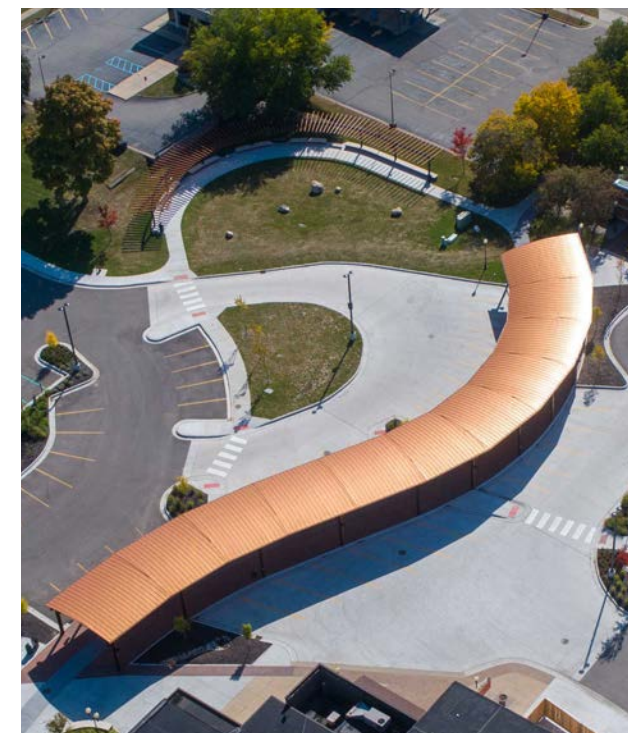

LOCATED IN THE HEART OF GRANDVILLE, LOCAL FARMERS MARKET GETS AN UPGRADE.

Farmers Markets are a place to support local farmers, musicians, artisans and to connect with your diverse community. ICON's custom Barrel Vault serves as protection from nature's elements to allow patrons to stay longer, and to create memorable experiences with their families and friends. The Copper Penny roof, which creates elevated distinction for this structure, was curved on site to follow the walking path below. The shelter features beautifully crafted tongue and groove planks and lights add to the pleasing and comforting experience.

Pearl Street Park | Charlotte, NC

FEATURED PROJECT



A REVITALIZED PARK HONORS A RICH HISTORY AND CELEBRATES TODAY'S COMMUNITY.

For many decades, Pearl Street Park has stood in the Brooklyn neighborhood of Charlotte. It originated, complete with gardens and sports fields, to provide park land to the African American population living in and around the area. Land for the park was purchased by the city from the Thompson Orphanage in 1943, and over the years has been the site of Victory Gardens, football practice for Second Ward High School, and many family gatherings. Today, it has been completely renovated while honoring its history and landscape. ICON worked in collaboration to design both a restroom and a multi-purpose pavilion which often hosts performances and community events, so the park can continue to serve families for many years to come.

Old Town Plaza | Elk Grove, CA

FEATURED PROJECT



GIVING A NOD TO A HISTORIC TRAIN DEPOT, THIS PROJECT GIVES THE TOWN A CENTRAL LOCATION TO HOST A RANGE OF EVENTS.

Gather at Old Town Plaza to discover the city's quaint history and charm. This massive collaboration features a custom Two-Tiered Interval Gabled Rectangular unit with beautifully crafted beams and custom masonry wraps. The structure will be used for anything from wedding receptions to outdoor concerts, to festivals and community events, and everything in between. Outdoor seating, a clock tower, and beautifully landscaped grounds round out this flawlessly manicured space.

Old Downtown | Las Vegas, NV

FEATURED PROJECT



**A GLOWING WORK OF ART
REVITALIZES SECTIONS OF
OLD DOWNTOWN LAS VEGAS.**

These eye-catching freestanding cantilevered structures line the promenade on 3rd Street between Bonneville and Charleston Avenue. Internal illumination increases pedestrian safety throughout late night hours while pulling inspiration from the famed Las Vegas strip.

Community Center | Piscataway, NJ

FEATURED PROJECT



A COMBINATION OF A BEAUTIFULLY CRAFTED FILTERED LIGHT ARBOR AND A TRADITIONAL GABLE SHELTER BRING VISUAL INTEREST AND SHADE TO A NEW JERSEY COMMUNITY.

Piscataway's renovated Community Center boasts a Filtered Light Arbor that provides patrons partial shade from the sun. By laser engraving wave-like designs that shine through the arbor, this filtered light arbor is custom made to pair perfectly with the splash pad. The Gable covers tables and chairs for taking a break, eating lunch, or catching up on some e-mails.

Mission Point | Mackinac Island, MI

FEATURED PROJECT



*Photo credit Ashley Slater Photography



MISSION POINT RESORT'S FABRIC SHELTER DEMONSTRATES A COLLABORATION OF DETERMINATION, A LITTLE CREATIVITY, AND A GORGEOUS OUTCOME.

Located on Mackinac Island, nestled right beside the ocean, this stunning Two-Tier Square Shade is used for weddings, receptions, and corporate retreats. Since no cars are allowed on the island, a combination of old-fashioned horse-pulled buggies and manpower were responsible for delivering material to the final site. The result is a breathtaking icon of celebration that also provides protection from the sun.

Structural Art

STYLE GUIDE



GULF COAST TOWN CENTER PROJECT | FORT MEYERS, FLORIDA

Structural Art

LOOKING FOR SOMETHING LESS CONVENTIONAL THAN A TRADITIONAL SHELTER TO FINISH YOUR PROJECT? LOOK NO FURTHER THAN STRUCTURAL ART.

This example of a non-traditional structure stands as the artistic centerpiece in Town Center's play space. It features two swings on one end, lighting, and misting nozzles throughout. The overlapping pops of color create an aesthetically pleasing work of art. ICON partnered with Studio 431, the custom structures division of Landscape Forms Inc.



Our goal is to bring to life unique and memorable structures. We work with clients through a series of conference calls to blend our engineering expertise with their artistic vision.

IRONWORKS

STYLE GUIDE



IRONWORKS

IRONWORKS RETRO-INDUSTRIAL SHELTERS AND FURNISHINGS TAKE THEIR CUE FROM EARLY 20TH-CENTURY RAILROAD BRIDGES AND TRAIN STATIONS.

There can be a certain beauty in exposed hardware. IRONWORKS celebrates these connections by making them fashionable focal points.

- I-Beam columns with rivet plates
- Architectural grade Southern Yellow Pine glu-lam rafters
- 2X6 Southern Yellow Pine T&G roof deck
- Rod & clevis ties or arched cross bracing
- Stainless steel fasteners



Craftsman

STYLE GUIDE



Craftsman

ICON DESIGNED THE CRAFTSMAN SERIES™ IN RESPONSE TO A REQUEST MADE BY A LANDSCAPE ARCHITECT LOOKING FOR SHELTERS THAT MIMIC THE STYLE OF HOMES BUILT IN THE EARLY DECADES OF THE 20TH CENTURY.

Available in multiple design configurations including Squares, Hexagons, Octagons, Gables, and Barrel Vaults.

- Sizes available: Between 10' and 60'
- Roof Pitch: 6/12; optional roof pitches between 3/12 and 12/12
- Roof Decks: Multi-Rib, Mega-Rib, Standing Seam, 2x6 T&G
- Additional roofing: Fiberglass Shingles



Filtered Light Arbors

STYLE GUIDE



Filtered Light Arbors

UNIQUE SHADOWS ARE CAST ONTO THE PAVEMENT WITH OUR FILTERED LIGHT ARBORS. THE ROOF PANELS ARE CUSTOM DESIGNED, LASER-CUT, AND POWDER COATED TO BE USED IN AN ENDLESS ARRAY OF CONFIGURATIONS.



Swings

STYLE GUIDE



Swings

**INVOKE NOSTALGIA
AND MEMORIES OF
TIMES PASSED.**

One of our most requested additions, ICON swings are intended for placement alongside trails, walkways, or any area you're inclined to take a pause and take in the scenery. Limited motion swings in all-steel, or steel with wood inserts, are featured in these swing structures.



Liveshade

STYLE GUIDE



Liveshade

LIVESHADE GREEN ROOF SHELTERS ARE AN EXCELLENT ILLUSTRATION OF OUR CUSTOM CAPABILITIES.

Liveshade has been designed and engineered to support the weight of a plant ecosystem. Our engineers work directly with each location to ensure the vegetation used is native to the area.



This structure is the perfect choice to add a captivating look and atmosphere to your space.

DSA Shelters

STYLE GUIDE



DSA Shelters

ICON'S TEAM OF KNOWLEDGEABLE ENGINEERS WORK DILIGENTLY TO CREATE HIGH-QUALITY DSA APPROVED SHELTERS.

While we do have pre-approved structures on file, we specialize in custom projects to meet the needs of every unique customer in the California Public Schools.



ICON DSA approved projects include Picnic Pavilions, Outdoor Classrooms, Stadium Seating Coverage, Parking Covers, Dugouts and Walkways.

Industry Standards

Industry Standard shelters are commonly found in the pre-engineered, manufactured shelter industry. These traditional shelters can be customized through a wide range of sizes and accessories.



Square Shelters

ROOF PITCH	ROOF DECKS	ADDITIONAL ROOFING
6/12 **	Mega-Rib	Fiberglass Shingles
	Multi-Rib	
	Standing Seam	
	2x6 T&G	

** Optional pitches between 4/12 and 12/12





Hexagon Shelters

ROOF PITCH	ROOF DECKS	ADDITIONAL ROOFING
6/12 **	Mega-Rib	Fiberglass Shingles
	Multi-Rib	
	Standing Seam	
	2x6 T&G	

** Optional pitches between 4/12 and 12/12



Octagon Shelters

ROOF PITCH	ROOF DECKS	ADDITIONAL ROOFING
6/12 **	Mega-Rib	Fiberglass Shingles
	Multi-Rib	
	Standing Seam	
	2x6 T&G	

** Optional pitches between 3/12 and 12/12





Rectangle Gable Shelters

ROOF PITCH	ROOF DECKS	ADDITIONAL ROOFING
4/12 **	Mega-Rib	Fiberglass Shingles
	Multi-Rib	
	Standing Seam	
	2x6 T&G	

* Standard bay spacing: 20'-0"

** Optional pitches between 5/12 and 12/12



Rectangle Hip Shelters

ROOF PITCH	ROOF DECKS	ADDITIONAL ROOFING
4/12 **	Mega-Rib	Fiberglass Shingles
	Multi-Rib	
	Standing Seam	
	2x6 T&G	

* Standard bay spacing: 20'-0"

** Optional pitches between 5/12 and 12/12





Barrel Vault Shelters

ROOF PITCH	ROOF DECKS	ADDITIONAL ROOFING
4/12 **	Mega-Rib	Fiberglass Shingles
	2x6 T&G	

* Standard bay spacing: 20'-0"

** Optional pitches between 5/12 and 12/12



Interval Shelters

ROOF PITCH	ROOF DECKS	ADDITIONAL ROOFING
8/12 - 12/12	Mega-Rib	Fiberglass Shingles
	Multi-Rib	
	Standing Seam	
	2x6 T&G	





Stretched Shelters

ROOF PITCH	ROOF DECKS	ADDITIONAL ROOFING
4/12 **	Mega-Rib	Fiberglass Shingles
	Multi-Rib	
	Standing Seam	
	2x6 T&G	

* Standard bay spacing: 20'-0"

** Optional pitches between 5/12 and 12/12



Dual Slope Shelters

ROOF PITCH	ROOF DECKS	ADDITIONAL ROOFING
4/12 **	Mega-Rib	Fiberglass Shingles
	Multi-Rib	
	Standing Seam	
	2x6 T&G	

* Standard bay spacing: 20'-0"

** Optional pitches between 5/12 and 12/12





Decagons and Dodecagons

ROOF PITCH	ROOF DECKS	ADDITIONAL ROOFING
6/12 **	Mega-Rib	Fiberglass Shingles
	Multi-Rib	
	Standing Seam	
	2x6 T&G	



* Standard bay spacing: 20'-0"

** Optional pitches between 5/12 and 12/12

Mono-Slopes

ROOF PITCH	FLAT ROOF DECKS
4/12 **	Mega-Rib
	Multi-Rib
	Standing Seam
	2x6 T&G



* Maximum bay spacing: 20'-0"

** Optional pitches between 3/12 and 8/12



Other Structures

Mini-Shelters

ROOF PITCH	ROOF DECKS	ADDITIONAL ROOFING
------------	------------	--------------------

4/12 **	Mega-Rib	Fiberglass Shingles
---------	----------	---------------------

	Multi-Rib	
--	-----------	--

	Standing Seam	
--	---------------	--

	2x6 T&G	
--	---------	--

* Standard bay spacing: 20'-0"

** Optional pitches between 5/12 and 12/12



Bandshells

ROOF PITCH	ROOF DECKS	ADDITIONAL ROOFING
------------	------------	--------------------

3/12 - 12/12 **	Mega-Rib	Fiberglass Shingles
-----------------	----------	---------------------

Curved Roof	Multi-Rib	
-------------	-----------	--

	Standing Seam	
--	---------------	--

	2x6 T&G	
--	---------	--

* Standard bay spacing: 20'-0"

** Roof pitches vary between 3/12 - 12/12 and curved





Partial Shade & Arbors

Beyond your basic garden arbor. These structures can be all steel, all wood, or a combination of both. Perforated, laser cut, and fabric shades can be integrated into the structure.





Entry Arches

Options and accessories:

- Curved arches
- Laser-cut medallions
- Color vinyl medallions
- Custom laser-cut arches
- Laser-cut lettering
- Custom shapes and sizes



Pedestrian Bridges

Bridges are available in widths from 4' to 8' wide, and lengths up to 60' in length. Handrails for bridges can be selected from the options on page 63.



Mailbox Shelters

ROOF PITCH	ROOF DECKS	ADDITIONAL ROOFING
4/12 **	Mega-Rib	Fiberglass Shingles
	Multi-Rib	
	Standing Seam	
	2x6 T&G	

* Standard bay spacing: 20'-0"
 ** Optional pitches between 5/12 and 12/12





Clock Towers

Clock Towers are highly customizable and are available in a multitude of sizes. They can include GPS systems, illumination, and specialized clock faces.

ILLUMINATION	TIME CONTROL	POWER
Back-lit	with GPS control	120V/220V AC
Non-Illuminated	without GPS control	7-year Lithium Battery (Non-Illuminated only)



Umbrella Shelters

ROOF PITCH	ROOF DECKS	ADDITIONAL ROOFING
6/12 **	Mega-Rib	Fiberglass Shingles
	Multi-Rib	
	Standing Seam	
	2x6 T&G	

* Standard bay spacing: 20'-0"

** Optional pitches between 3/12 and 5/12



Message Shelters

ROOF PITCH	ROOF DECKS	ADDITIONAL ROOFING
3/12 - 6/12	Mega-Rib	Fiberglass Shingles
	Multi-Rib	
	Standing Seam	
	2x6 T&G	



Fabric Shades

ICON produces rectangular, square hexagonal and octagonal fabric shelters, shade sails, and custom structures using a combination of materials to achieve the design intent.





Picnic Table Capacities

LET ICON HELP YOU DETERMINE THE NUMBER OF TABLES FOR YOUR NEXT SHELTER.

Use the chart below as an easy reference for your planning.

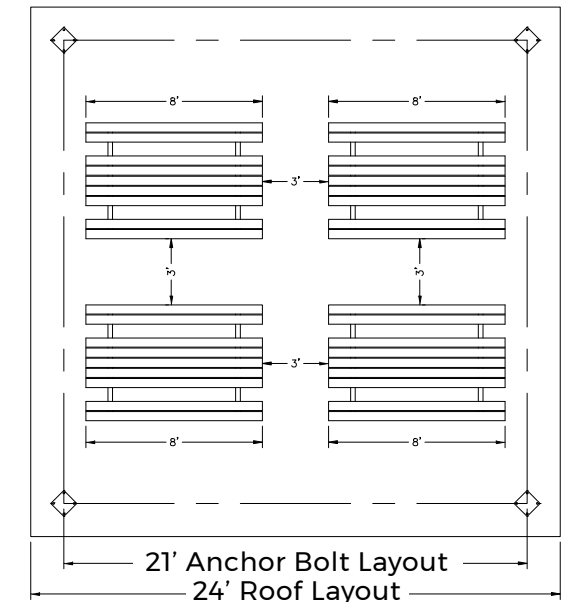
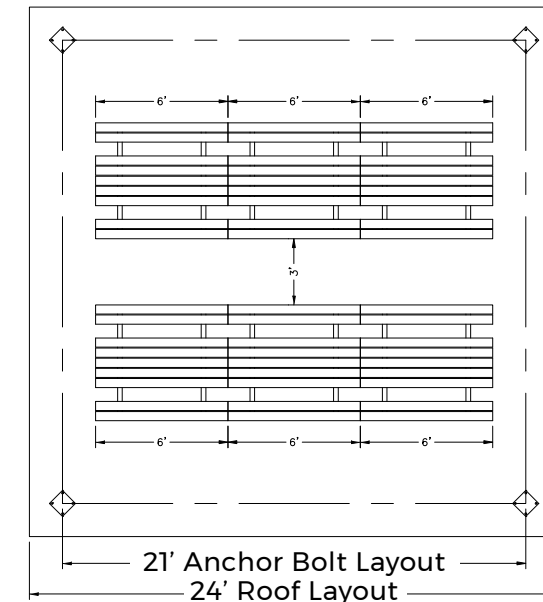

RG & RH	6' TABLES	8' TABLES
12 x 24	2	2
12 x 44	5	4
16 x 64	7	6
16 x 24	5	3
16 x 44	8	7
16 x 64	12	10
20 x 24	5	4
20 x 44	9	7
20 x 64	14	10
24 x 24	6	5
24 x 44	13	10
24 x 64	20	14
30 x 44	20	15
30 x 64	28	21
30 x 84	36	27
30 x 104	44	33
36 x 44	20	13
36 x 64	28	19
36 x 84	40	26
36 x 104	48	32
40 x 44	20	18
40 x 64	32	25
40 x 84	40	36
40 x 104	48	44
50 x 64	49	38
50 x 84	63	49
50 x 104	77	60
50 x 124	80	65

SQ	6'	8'	HEX	6'	8'
12	1	1	12	1	1
16	4	2	16	2	1
20	4	3	20	4	2
24	6	4	24	6	3
28	8	6	28	7	4
30	12	10	30	8	6
34	14	12	36	10	8
36	16	14	40	14	11
40	23	18	44	18	13
44	28	22	48	22	17
48	32	26	50	24	19
50	36	28	56	30	24
60	50	41	60	34	25
			66	42	32
			70	46	34
OCT	6'	8'			
16	1	1			
20	2				
24	3				
28	5				
30	6				
34	7				
36	8				
40	10				
44	14				
48	18				
58	26				
66	32				
72	40				



NEED MORE HELP?
Let us layout your structure and an adequate number of tables for you.

Warranty

ICON'S WARRANTY AND TERMS

ICON LIMITED WARRANTY

ICON Shelter Systems, Inc. warrants to the original purchaser of its products that it will provide materials free from manufacturing defects, that will be structurally sound, and can be assembled with normal expertise and tools required and practiced in the construction industry. The limited warranty is for a period of ten (10) years from the date of invoice with the following terms and conditions:

This warranty is in effect only if the structure has been assembled and installed strictly in accordance with ICON installation drawings and good construction practices and has been subjected only to normal use and exposure.

This warranty is valid only if the structures are maintained according to proper maintenance procedures; have been subjected to only normal use for the purpose for which the goods were designed; have not been subjected to addition or substitution of parts; and have not been modified, altered, or repaired without the approval of an Icon Shelter Systems' approved representative in any respect which, in the judgment of Icon Shelter Systems, affects the condition or operation of the structures.

The owner shall notify ICON to arrange for an inspection within thirty (30) days after discovery of any defect under this warranty, and before any alteration or repair is made or attempted.

ICON is in no way responsible for damages caused by others, including vandalism,

fire, lightning, or acts of God, corrosion caused by moisture, chemicals, air or salt spray, pollution, or infestation by rodents or other vermin.

FULL WARRANTY

For a full detailed warranty scan the QR code below



TERMS

Accounts that have been authorized have a 30-day net payment period.



ICON
Shelter Systems Inc

Call us to learn more at
800-748-0985 or visit
ICONSHELTERS.COM

Customizations

I-ROCK GFRG STONE BASES

ICON developed a pre-cast faux stone base to simulate stacked ledge rock piers. Cast in two section of glass-fiber reinforced concrete (GFRG) and joined onsite, I-Rock Bases eliminate the need to have a stone mason custom build piers.

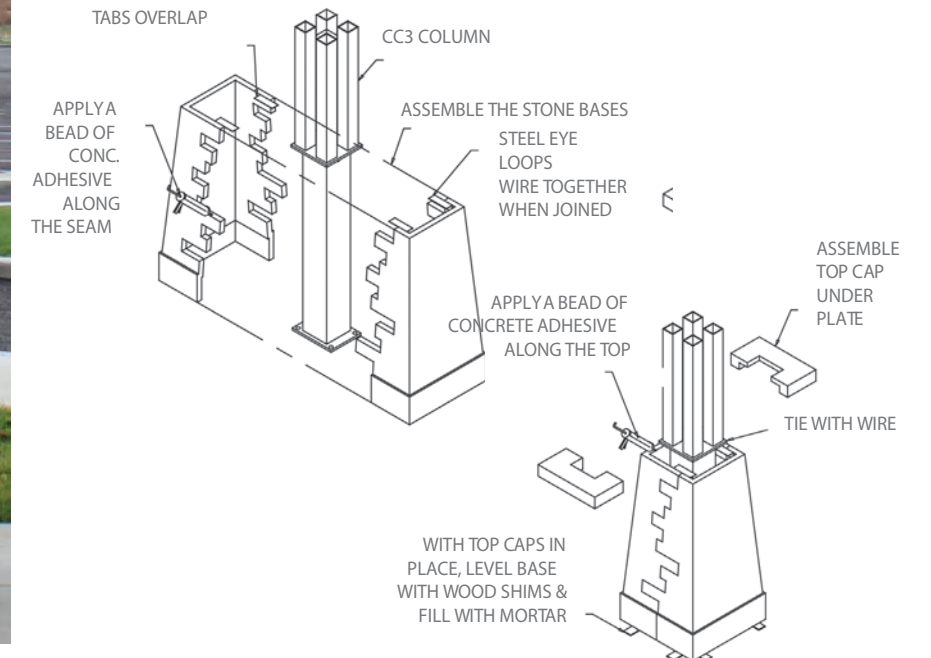

* Multiple stone color options available. Contact us to see all options.

ORNAMENTATION

Craftsman ornamental rails for eaves and clerestory.

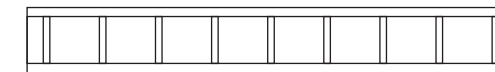

Open Pane Ornament

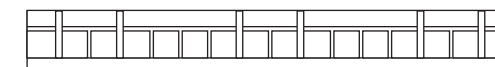

Simulated Leaded Glass Ornament

PEAK TREATMENTS

Cupolas or a Finial Peak Cap are available to provide a polished finish.



Craftsman Series™
Cupola



Craftsman Series™
Finial Peak C

VENTED AND CLERESTORY ROOFS

Most ICON Industry Standard Shelters are available in multiple roof tier configurations. Two tiers are available on all shelters while three tiers are available on shelters over 24'. The Clerestory roof provides room to install ornamental rails or louvered vent closures.



Interior view of Vented roof option



Interior view of Clerestory roof option

OPTIONAL COLUMNS

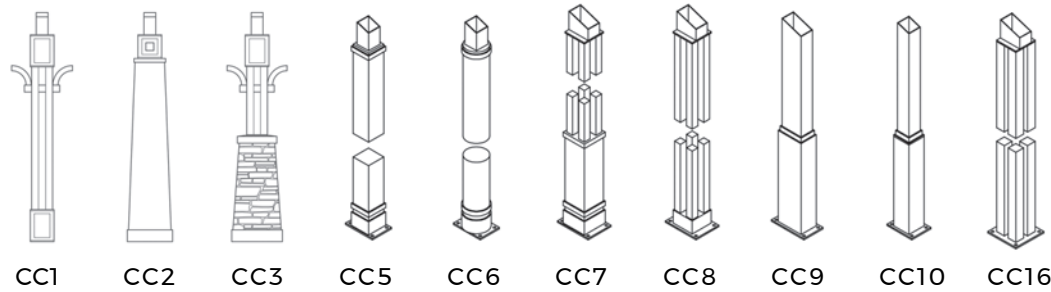

COLUMN-TO-BASE CONNECTION



Standard base connection

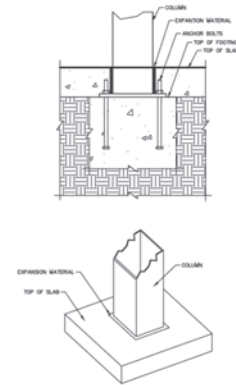

Surface mount with base covers

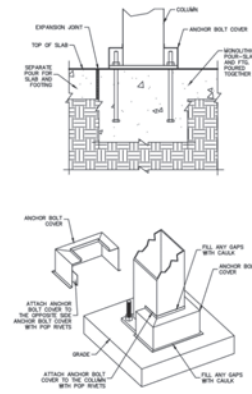

CUPOLAS

Cupolas add flare, turning a shelter into a statement shelter. ICON offers a variety of cupolas using glass, steel rods, shutters, and ornamental detail to meet both traditional and modern design aesthetics. Don't see what you like? Contact us for a custom design.



HANDRAILS AND ORNAMENTATION

Ornamental Rails are another way to create a more signature look and can be added to most ICON structures. ICON has a variety of standard designs inspired by common architectural influences. Like many of our accessories, ICON's creative designers can help create a custom look specific to your project.

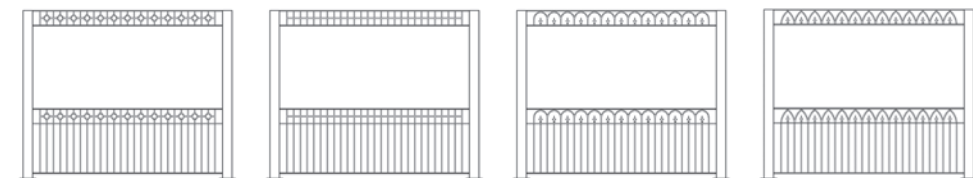
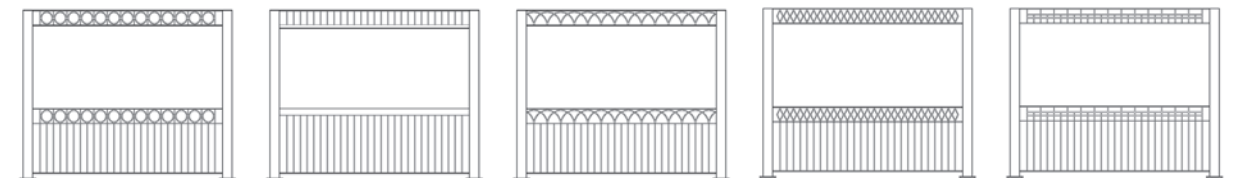

WEATHERVANES

Sometimes it's the little things. Accessorize your shelter peaks, ridges and cupolas with a standard weathervane. From roosters to horses to bald eagles and maps, make a statement with this small but striking addition.



GABLE TREATMENTS

A creative way to add a small touch is with a Gabled Treatment. Ideas include spires, laser-cut medallions and rod and clevis ties.



CLOCKS

Clocks are a classic addition, practical as well as charming. Clocks can be mounted onto a shelter cupola or frame.



EMBLEMS & SIGNS

For a fully personalized experience, ICON can add your logo, emblem, or artwork to your shelter. Create an impactful statement and represent the core of your community.

Primary Roof Decks for Steel Frame Structures

24 GAUGE STEEL PANELS

The 24 ga. galvalume roof panels have a Kynar 500 paint finish. Multi-Rib and Mega-Rig are 36" wide panels that are pre-cut in our factory to fit your shelter. Medallion-Lok standing seam is provided uncut, to be cut to fit in the field by others.

All steel roof panels have a standard, white-washed color on the underside of the panel. This will be visible without a sub roof deck.

2X6 TONGUE AND GROOVE

The 2x6 tongue and groove (T&G) wood roof is kiln dried Western Lodgepole Pine. T&G requires finished roofing materials.



Color & Roof Decking Options

24 GAUGE STEEL ROOF COLORS



WOOD SHELTER FRAME & ROOF DECKING



STANDARD POWDER COAT COLORS



PREMIUM POWDER COAT COLORS*



*Available for an additional charge.

Contact us to discuss custom color options.

****Please note, this is a representation of ICON's colors. Actual colors may vary.**



1455 LINCOLN AVENUE
HOLLAND, MI 49423

800.748.0985



ICONSHELTERS.COM