



**Shade** ▲▲  
**systems**™

*the coolest solutions under the sun®*



To Our Valued Customers, Representatives, and Employees:

Shade Systems™ has been the industry leader for offering beautiful and effective shade solutions to protect the public from the sun's harmful U.V. rays since our Company's inception in 2003. To help you choose the best shade products for your needs, we are once again proud to publish the most comprehensive product catalog in the shade industry.

A perfect example of our leadership is our patented Turn-N-Slide™ easy canopy removal and re-attachment system. At times imitated by our competitors – but never equaled – our time-tested Turn-N-Slide fastening system makes it easy for most anyone on your staff to quickly remove and re-attach the canopy in the event of severe storm or for the winter season. Shade Systems was the first with such a system, and our Turn-N-Slide is still the most-used fastening system with the longest, most successful track record. Please see page 5 for details.

Turn to page 22 for our innovative 'Sail' products, the highest quality fabric tension structures on the market. Like our frame-supported shade products, Sails also feature an easy-to-use release system for quick removal of the canopies. Engineered to last and designed for beauty, Sails add an imaginative skyline to your site while providing much-needed shade.

Starting on page 40, consider the Tornado® - one of our most stunning shade structure designs with sculpture-like appeal across a broad spectrum of environments where shade is needed but in an aesthetically-appealing style.

For all the above reasons, along with the most air-tight warranties on the market, Shade Systems is proud to be the most-specified name in the shade business. We look forward to serving your shade needs for many years to come.

Sincerely,



Alan Bayman  
President





PROJECT INFO

**On this Page:**

UK Pediatrics - Family Care Center  
University of Kentucky - Lexington, Kentucky  
See page 28 for more Multi-Level 'Sails' ideas

**On the Cover:**

27th Avenue Beachfront Park - New Smyrna Beach, Florida  
See page 22 for more 'Sails' ideas

**TABLE OF CONTENTS**

Why Choose Shade Systems?.....	04	Multi-Level 'Sails' .....	28
Turn-N-Slide™ Easy Fastening System.....	05	Shade Kites.....	32
Mega Spans.....	06	Offset Single Post Pyramids .....	34
Squares & Rectangles .....	10	Single Post Pyramid/Single Post Umbrella ..	36
Hexagons & Octagons .....	12	Double Post Hip/Single Post Hypar.....	37
Wraparound Single Cantilevers.....	14	Shade Walks.....	38
Single Cantilevers .....	16	Tornado® Shades.....	40
Offset T-Cantilevers.....	17	Parking and Vehicle Protection.....	44
Double Cantilevers.....	18	Night Lighting.....	46
T-Cantilevers .....	19	Fabric Colors .....	48
Arc Cantilevers.....	20	Post Pads/Metal Powder-Coat Colors.....	49
'Sails' .....	22	Specifications & Warranty .....	50





# Why Choose Shade Systems?

## ✓ TURN-N-SLIDE™ EASY FASTENING SYSTEM



- Makes it easy to remove and re-attach the fabric canopy for the winter season or in case of severe storm such as hurricanes (most other shade companies' products are permanent and require professional installers to remove and re-install the canopy)

- Only patented and time-tested system of its kind — in continuous use nationwide since 2003
- See our demonstration video at: [www.shadesystemsinc.com](http://www.shadesystemsinc.com)

## ✓ ONE-POINT 'SAILS' ATTACHMENT SYSTEM

- No need to thread messy cables – each corner of the 'Sails' fabric canopy features a stainless steel bracket with just one tensioning bolt to easily attach or remove the canopy.
- Cables are permanently concealed in the hems and terminate in the stainless steel bracket – you never have to touch them!
- All cables and hardware are corrosion resistant stainless steel for maximum durability.
- Please see page 24 for more details.



## ✓ MOST EXTENSIVE 7-STEP POWDER-COATING PROCESS IN THE INDUSTRY FOR CORROSION-RESISTANCE

1. **Sandblasting.** Metal parts are sandblasted to completely remove any surface oils and rust.
2. **Mechanical smoothing.** Any remaining foreign matter is mechanically removed from surfaces by sanding, grinding, and rounding rough edges to smoothness.
3. **Initial Surface Preparation.** A heavy-duty liquid cleaner is applied for initial surface preparation.
4. **Corrosion resistant Coating.** Liquid detergent iron phosphate is applied, resulting in a superior quality corrosion resistant sub-coating.

5. **Final Surface Preparation.** All metal parts are then sealed using a reactive, non-chrome sealer for enhanced corrosion protection and increased paint adhesion.

6. **Coastal Primer.** Prior to powder-coating, a rust inhibiting coastal primer is applied for maximum corrosion resistance in the most demanding outdoor environments.

7. **Application of Powder-Coating.** Lastly, PPG Envirocron™ Ultradurable powder coatings are applied for a durable and uniform final color finish.



## ✓ EXTENSIVE USE OF STAINLESS STEEL FOR MAXIMUM CORROSION RESISTANCE

- All stainless steel hardware
- All stainless steel cables

## ✓ 100% U.S. MADE – ALL UNDER ONE ROOF IN OUR FLORIDA FACTORY

Watch our 5-minute Factory Tour video:  
[www.shadesystemsinc.com](http://www.shadesystemsinc.com)

## ✓ MOST COMPREHENSIVE WARRANTIES IN THE INDUSTRY

- 20 yrs** on metal frames against rust-through corrosion
- 10 yrs** on CoolNet™ shade fabric against deterioration
- 10 yrs** on CoolNet™ stitching thread against deterioration
- 10 yrs** on Turn-N-Slide™ Easy Fastening System
- 10 yrs** on stainless steel cables

*\*\* And none of the above warranties are pro-rated! \*\**



# Turn-N-Slide™ Easy Fastening System



## STEP 1:

Use our special vandal-resistant tool to remove access cap

Reverse the steps to re-attach

it's that easy!



## STEP 2:

Turn concealed nut using a standard socket wrench. Attachment hook moves backward, releasing the canopy cables.



## WHAT IS THE TURN-N-SLIDE™?

Our patented Turn-N-Slide™ Easy Fastening System is an ingenious mechanism which comes standard on all frame-supported Shade Systems products and makes removal and re-attachment of the canopy quick and easy for most anyone on your staff. And it's covered by a 10 year warranty.

## WHY DO WE NEED SUCH A MECHANISM ON OUR SHADE?

If you are located in colder climates, you will want to remove your canopy and store it for the winter season. This prolongs the canopy's life by not subjecting it to snow loads and winter storms. Likewise, if you are located in an area subject to hurricanes or tornadoes, the Turn-N-Slide allows quick removal of the canopy as soon as you receive a storm warning.

## WHAT DOES THE COMPETITION OFFER?

Good question. The competition's canopies are mostly designed to be permanent, and require special tools and oftentimes the services of professional installers for removal and especially re-installation. Ask the competition to describe the specific steps required to remove and then re-attach their canopy, and judge for yourself if the same thought has gone into their product as the Turn-N-Slide.

## WHERE CAN WE LEARN MORE ABOUT THE TURN-N-SLIDE?

Visit our website at [www.shadesystemsinc.com](http://www.shadesystemsinc.com) to see a 6-minute online demonstration video of how easy it is to remove and then re-attach your Shade Systems canopy.



# Mega Spans



01

**EXERCISE COURTS**

02

**PICKLEBALL COURTS**



06

[www.shadesystemsinc.com](http://www.shadesystemsinc.com)  
1-800-609-6066





03

## BASKETBALL COURTS

Mega Spans comprise our largest pre-engineered frame-supported shade structures, providing clear span coverage for spaces ranging from 900 square feet to over 5,000 square feet. Featuring heavy schedule 40 pipe columns and structural steel beams, Mega Span steel frames are shipped as easy-to-assemble bolt-together components requiring no in-field welding or fabrication.

Our exacting specifications include all stainless steel hardware and tensioning cables, and a durable powder-coat finish on all metal components in your choice of brilliant colors. And like our smaller frame-supported Squares & Rectangles on pages 10-11, Mega Spans also include our remarkable Turn-N-Slide™ easy canopy fastening system. The Turn-N-Slide makes it easy to quickly remove and then re-attach the CoolNet™ fabric canopy for the winter season or in the event of severe storms such as hurricanes.

Please refer to the Turn-N-Slide details on page 5.

### MEGA SPANS ARE PERFECT FOR:

- Playgrounds
- Dog Parks & Pet Boarding
- Parking & Car Washes
- Seating & Concessions
- Exercise & Sport Courts



- 01 Rivergum Green canopy • Latte Tan frame • 30 x 50 x 12' eave height
- 02 Eggshell White canopy • Jet Black frame • 60 x 90 x 13 eave height (shown with optional independent canopies)
- 03 Bright Red canopy • Jet Black frame • 54' x 90' x 12' eave height (shown with optional post pads and valances)
- 04 Aquatic Blue canopy • Jet Black frame • 36' x 38' x 10' eave height



04

## SEATING & CONCESSIONS



www.shadesystemsinc.com  
1-800-609-6066

07



# Mega Spans

PERSPECTIVE

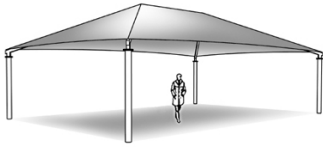

FRONT

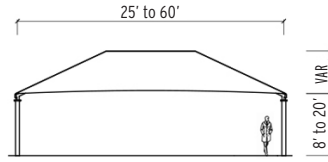

SIDE

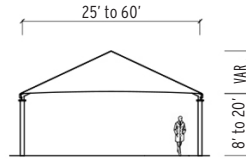

TOP

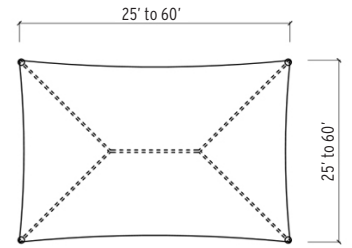

01

## PLAYGROUNDS



02

## BASKETBALL COURTS

01 Navy Blue canopy • Gunmetal Grey frame • 56' x 100' x 14' eave height

02 Lime Green canopy • Blue Streak frame • 56 x 110 x 20' eave height



## FEATURED PROJECT

Holland Park • Palm Coast, Florida

Light Blue canopy • Coffee Brown frame • 43' x 76' x 12' eave height

Shade Systems™ is pleased to have provided one of its huge Mega Span shade covers for the newly renovated bocce ball court at Holland Park in Palm Coast, Florida.

To protect players and spectators alike from the sun's harmful U.V. rays, the City of Palm Coast staff worked with the Shade Systems design team to develop a large enough shade to cover the entire court. Further, the City also specified lighting accommodations to be included along the steel rafters, to create a brightly lit and safe environment for night games.



*Available with optional night lighting (see page 46 for details)*





# Squares & Rectangles

Available in sizes from 10' x 10' to 25' x 25'



Square & Rectangular designs form the backbone of our most effective and economical shade offerings. Engineered to meet the stringent International Building Code [IBC], these functional structures are available in a variety of colors, heights and sizes, and feature our remarkable Turn-N-Slide™ quick-release canopy fastening mechanism in case removal of the canopy becomes necessary due to severe storm or winter weather.



## SQUARES & RECTANGLES ARE PERFECT FOR:

- Playgrounds
- Pools & Waterparks
- Bleachers and Dugouts
- Tennis and Shuffleboard
- Seating & Concessions
- Hotels, Resorts, Restaurants





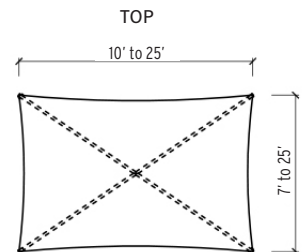
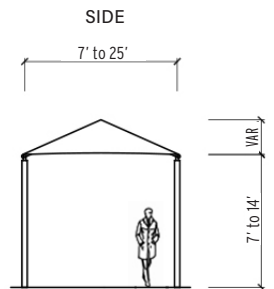
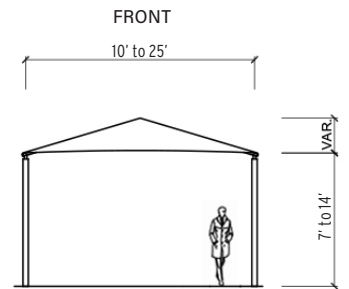
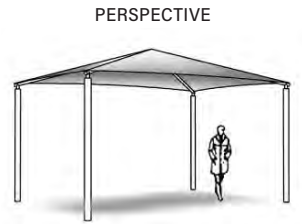

- 01 Forest Green canopy • Evergreen frame • 20' x 20' x 8' eave height
- 02 Canary Yellow canopy • Jet Black frame • 8' x 30' x 7' eave height
- 03 Desert Sand canopy • Coffee Brown frame • 20' x 25' x 12' eave height

- 04 Forest Green canopy • Evergreen frame • 20' x 25' x 12' eave height
- 05 Aquatic Blue canopy • Latte Tan frame • 18' x 18' x 8' eave height



# Hexagons & Octagons

Available in 16' diameter to 60' diameter



## HEXAGONS

### PERSPECTIVE



### SIDE

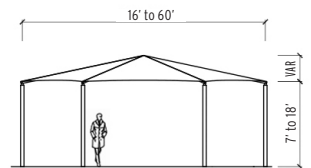

### TOP

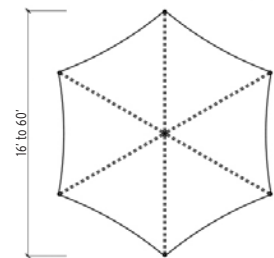

Hexagon and Octagon designs add a whimsical 'carousel' look to your play area or other outdoor gathering place. As with all our shade products, Hexagons and Octagons are engineered to meet the International Building Code (IBC), are available in a variety of heights and sizes, and feature our patented Turn-N-Slide™ easy canopy fastening system in case removal of the canopy becomes necessary. Please refer to the Turn-N-Slide details on page 5.

## HEXAGONS & OCTAGONS ARE PERFECT FOR:

- Playgrounds
- Picnic Areas
- Concessions





OCTAGONS

PERSPECTIVE



SIDE

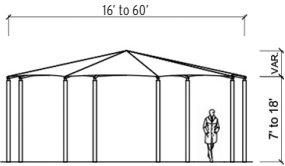

TOP

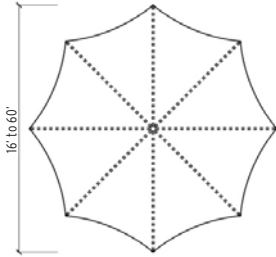

- 01 Aquatic Blue canopy • Alpine White frame • 33' dia. - 8' eave height
- 02 Forest Green canopy • Coffee Brown frame • 42' dia. - 12' eave height
- 03 Rivergum Green canopy • Alpine White frame • 60' dia. - 12' eave height

- 04 Forest Green canopy • Evergreen frame • 50' dia. - 12' eave height
- 05 Silver Grey canopy • Blue Streak frame • 40' dia. - 13' eave height



# Wraparound Single Cantilevers



## BLEACHERS

Light Blue canopy • Jet Black frame

Wraparound Single Cantilevers are linked together to create a continuously cool shaded space, and ingeniously engineered to keep the support posts to only one side. Especially near pools and other water activities where posts are not desirable close to the water, Wraparound Single Cantilevers provide the ideal solution for arranging seating and tables. They're also perfect as bleacher shade near sports fields for unobstructed sports viewing while enjoying cool comfort and sun protection.



## WRAPAROUND SINGLE CANTILEVERS ARE PERFECT FOR:

- Pools & Waterparks
- Bleachers and Dugouts
- Seating & Concessions
- Hotels, Resorts, Restaurants

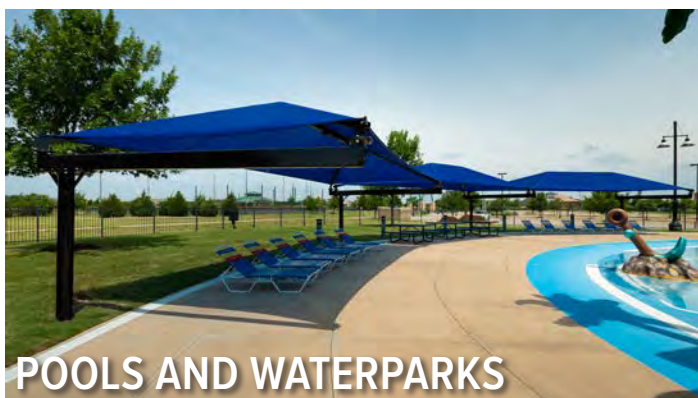

## POOLS AND WATERPARKS

Aquatic Blue canopy • Jet Black frame

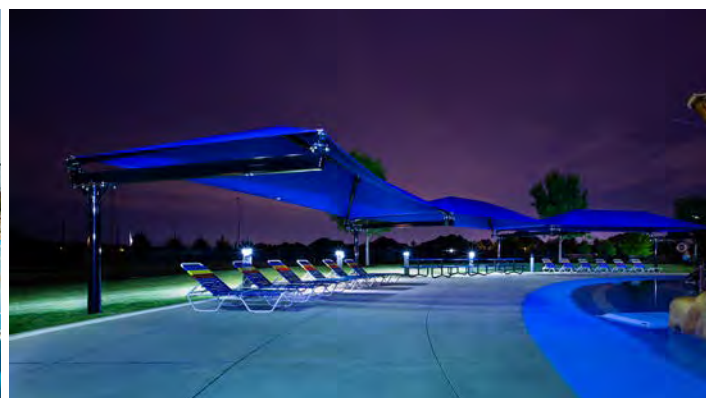



# FEATURED PROJECT

Russell Creek Park • Plano, Texas  
Desert Sand canopy • Blue Streak frame

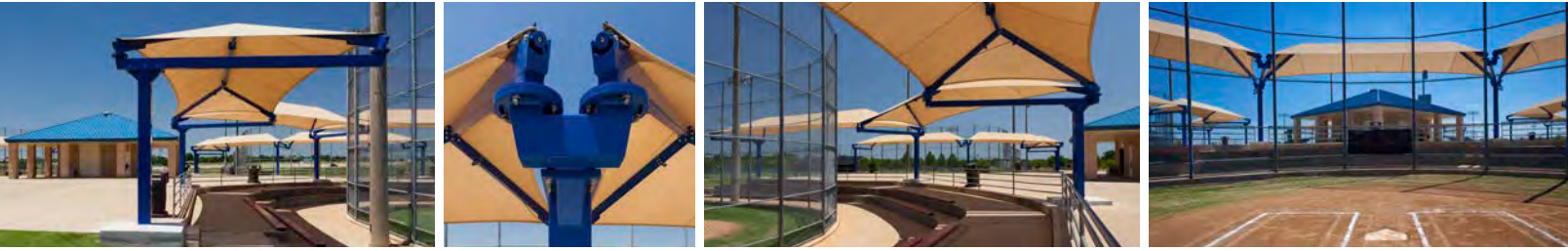



# Single Cantilevers

Available in sizes from 19' x 20' to 25' x 30'



01 BLEACHERS

## CANTILEVERS ARE PERFECT FOR:

- Bleachers
- Dugouts
- Pool Areas
- Picnic Areas
- Skate Parks
- Shuffleboard
- Seating Areas
- Tennis Courts

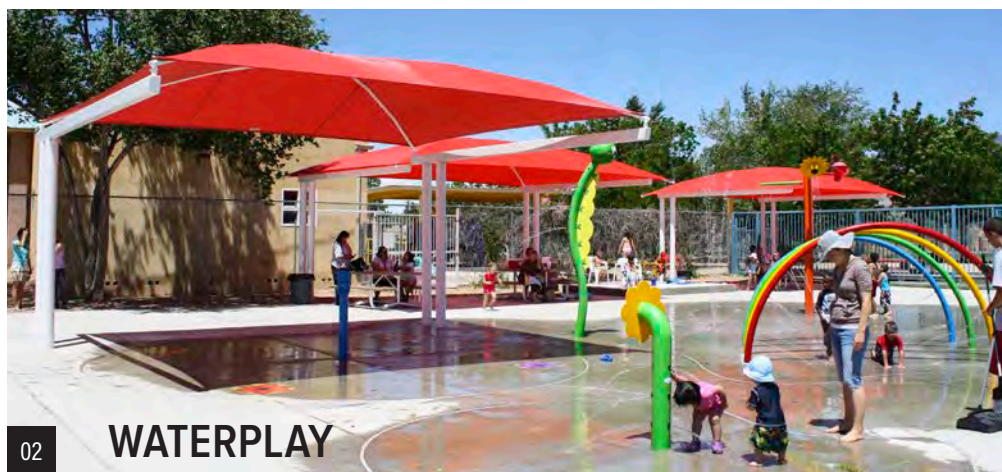

02 WATERPLAY

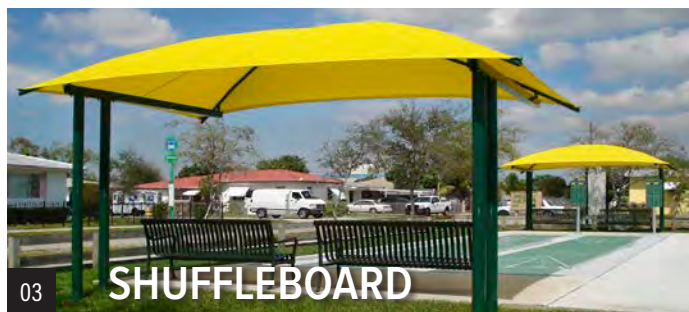

03 SHUFFLEBOARD



04 SEATING AREAS

## SINGLE CANTILEVER

### PERSPECTIVE

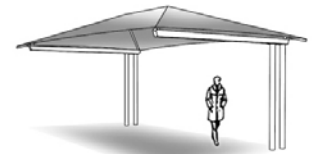

### FRONT

Up to 30'

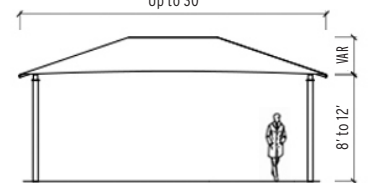

### SIDE

Up to 25'

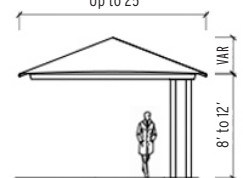

### TOP

Up to 30'

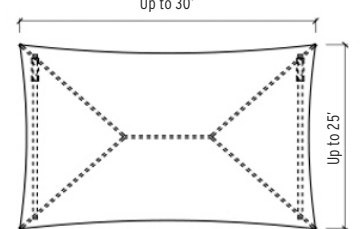

- 01 Desert Sand canopy • Blue Streak frame • 19' x 30' x 10' eave height
- 02 Bright Red canopy • Alpine White frame • 19' x 20' x 10' eave height
- 03 Canary Yellow canopy • Evergreen frame • 12' x 20' x 8' eave height
- 04 Grape Purple canopy • Sunshine Yellow frame • 19' x 21' x 10' eave height



# Offset T-Cantilevers

Available in sizes from 9' x 20' to 14' x 30'

## OFFSET T-CANTILEVER

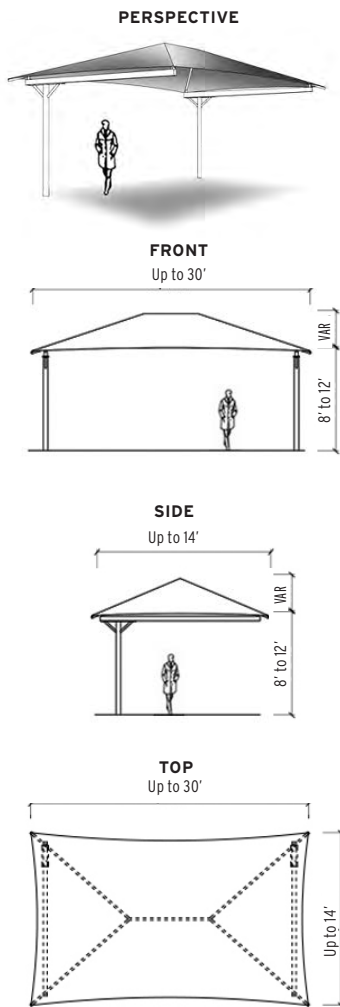

- 05 Desert Sand canopy • Latte Tan frame • 14' x 30' x 8' eave height
- 06 Brick Red canopy • Gunmetal Grey frame • 8' x 57' x 10' eave height
- 07 Aquatic Blue canopy • Jet Black frame • 10' x 30' x 12' eave height
- 08 Desert Sand canopy • Jet Black frame • 12' x 30' x 12' eave height



# Double Cantilevers

Available in sizes up to 38' x 30'



01 SEATING AREAS

## CANTILEVERS ARE PERFECT FOR:

- Bleachers
- Shuffleboard
- Picnic Areas
- Skate Parks
- Pool Areas
- Tennis Courts
- Dugouts
- Seating Areas



## DOUBLE CANTILEVER

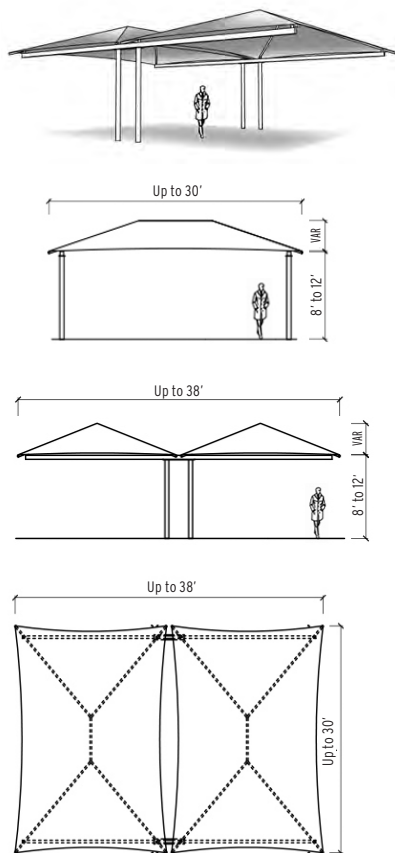

02 BLEACHERS

- 01 Grape Purple canopy • Jet Black frame • 38' x 30' x 8' eave height
- 02 Forest Green canopy • Jet Black frame • 28' x 30' x 12' eave height
- 03 Canary Yellow canopy • Jet Black frame • 15' x 30' x 12' eave height
- 04 Rivergum Green canopy • Evergreen frame • 12' x 25' x 10' eave height
- 05 Desert Sand canopy • Blue Streak frame • 17' x 35' x 10' eave height



# T-Cantilevers

Available in sizes from 8' x 18' to 17' x 35'



**SPORTS SHADE**

03



**TENNIS COURTS**

04



**BLEACHERS**

05

## T-CANTILEVER

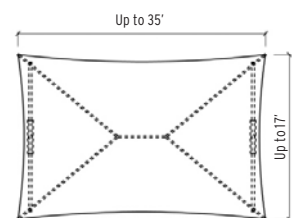
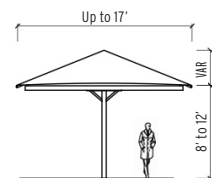
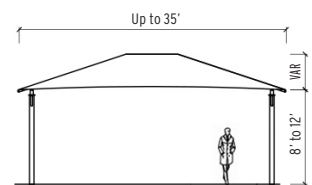



# Arc Cantilevers

Available in sizes up to 25' x 30'



Arc Cantilevers feature gracefully curved roof frames that cantilever out to provide effective shade with support columns that are kept back and out of the way. Engineered to meet the stringent International Building Code (IBC), these functional structures are available in a variety of colors, heights and sizes, and feature our remarkable Turn-N-Slide™ quick-release canopy fastening mechanism in case removal of the canopy becomes necessary due to severe storm or winter weather.

## ARC CANTILEVERS ARE PERFECT FOR:

- Pools & Waterparks
- Bleachers and Dugouts
- Seating & Concessions
- Hotels, Resorts, Restaurants



01 Eggshell White canopy • Coffee Brown frame

02 Light Blue canopy • Alpine White frame



## FEATURED PROJECT

Prairie View A&M University • Prairie View, Texas  
Desert Sand canopy • Jet Black frame • 15' x 34' x 16' eave height





# 'Sails' – The Sky is the Limit

Available in a virtually unlimited range of custom sizes and shapes



01 CAR WASHES



02 SEATING & CONCESSIONS



03 EXERCISE COURTS





04



05

Our innovative 'Sails' shade designs are a clever way to cover those odd-shaped areas where possible post locations are limited or where a unique aesthetic appearance is desired. Featuring stainless steel connections and hardware for long life, 'Sails' are pre-engineered in an endless variety of imaginative configurations to add visual interest to your play structure's skyline, while protecting children from the sun's dangerous U.V. rays with up to 99% sun screening. They are equally attractive and functional over spectator seating areas, pool decks, picnic courts, outdoor amphitheaters, sports fields, concessions, or any other outdoor gathering area where protection is needed from the sun's harmful U.V. rays.



06

**PLAYGROUNDS**

- 01 Rivergum Green canopy - Coffee Brown columns
- 02 Desert Sand and Brick Red canopies - Coffee Brown columns
- 03 Desert Sand canopy - Moss Green columns (optional color)

- 04 Light Blue and Eggshell White canopies - Alpine White columns
- 05 Aquatic Blue and Bright Red canopies - Alpine White columns
- 06 Desert Sand and Forest Green canopies - Latte Tan columns



# 'Sails'

## Insist on the Shade Systems Advantages!

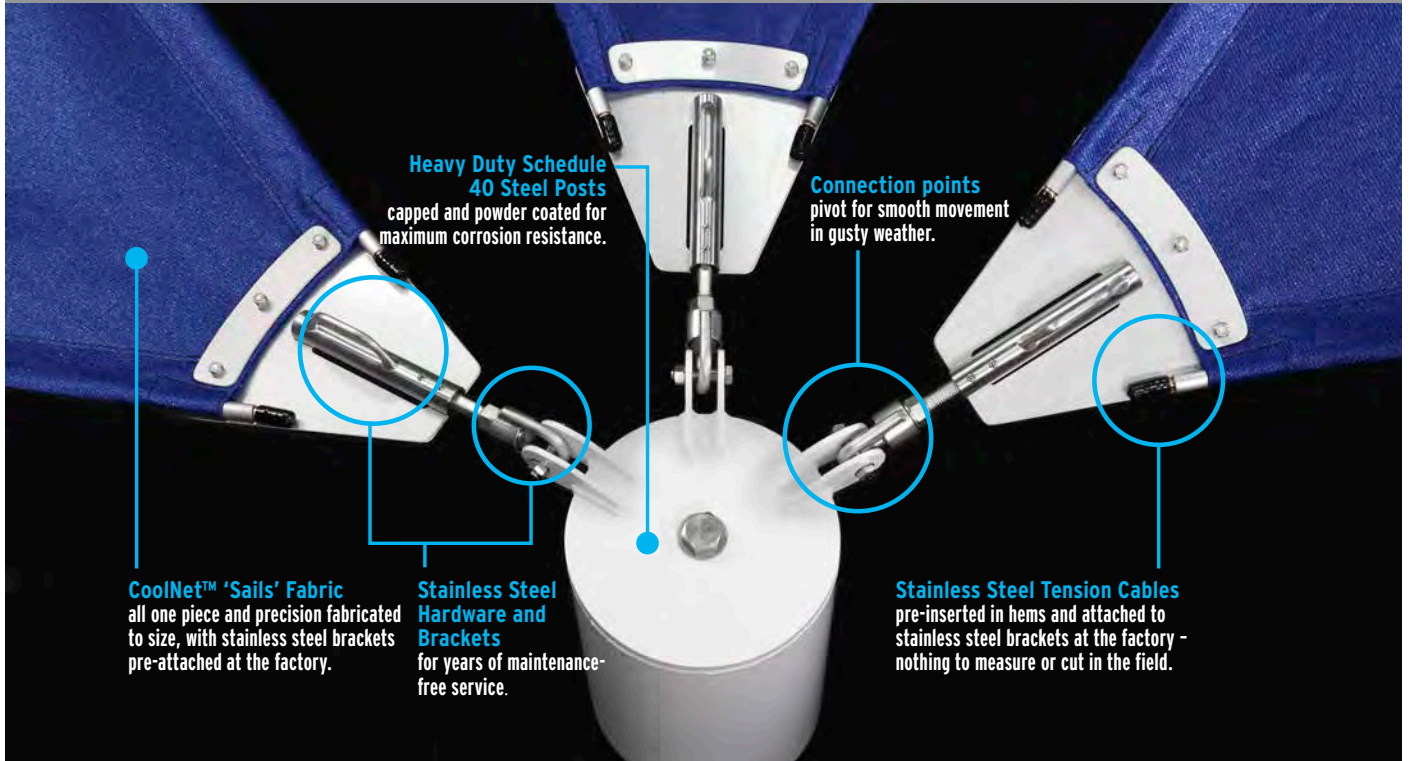

**Heavy Duty Schedule 40 Steel Posts** capped and powder coated for maximum corrosion resistance.

**Connection points** pivot for smooth movement in gusty weather.

**CoolNet™ 'Sails' Fabric** all one piece and precision fabricated to size, with stainless steel brackets pre-attached at the factory.

**Stainless Steel Hardware and Brackets** for years of maintenance-free service.

**Stainless Steel Tension Cables** pre-inserted in hems and attached to stainless steel brackets at the factory - nothing to measure or cut in the field.

## Don't settle for this:



**Cables are not pre-cut** and must be measured and threaded in the field.

**Non-stainless steel parts** develop corrosion and can fail.

**U-Bolts and clamps must be used** to secure cables - movement of metal against metal promotes wear.



**Tangle of cables** makes it difficult to remove sails for storms or winter.





POOLS & WATERPARKS

01



PLAYGROUNDS & SEATING

02



03

- 01 Aquatic Blue canopy • Gunmetal Grey columns
- 02 Desert Sand and Rivergum Green canopies • Alpine White columns
- 03 Lime Green canopy • Alpine White columns



‘SAILS’ ARE PERFECT FOR:

- Playgrounds
- Pools & Waterparks
- Seating & Concessions
- Hotels, Resorts, Restaurants



## FEATURED PROJECT

27th Avenue Beachfront Park • New Smyrna Beach, Florida

Lime Green, Aquatic Blue, Eggshell White canopies • Latte Tan columns





# 'SAIL' SHADES FOR PLAYGROUNDS & SEATING





# 'Sails'

Available in a virtually unlimited range of custom sizes and shapes

AVAILABLE WITH **NIGHT LIGHTING**  
(SEE PAGE 46 FOR DETAILS)



**BOARDWALKS  
& WALKWAYS**







**SEATING & CONCESSIONS** 02



**SPORTS FIELDS** 03



**PLAYGROUNDS** 04



**POOLS** 05



**WATERPLAY** 06

- 01 All photos on page: Navy Blue, Aquatic Blue, Desert Sand, and Eggshell White canopies - Alpine White columns
- 02 Light Blue canopy - Jet Black columns
- 03 Desert Sand canopy
- 04 Bright Red and Canary Yellow canopies - Alpine White columns
- 05 Aquatic Blue canopy - Latte Tan columns
- 06 Eggshell White and Canary Yellow canopies - Gunmetal Grey columns



# Multi-level 'Sails'

Available in a virtually unlimited range of custom sizes and shapes



01 STAGES & AMPHITHEATERS

Multi-level 'Sails' go beyond even our normal 'Sails' for multiple layers of imaginative sun protection. They still feature stainless steel connections and hardware for long life, but additionally include a powder-coated steel framework to support an intricate arrangement of multiple layers of fabric to visually stun as well as provide cooling shade. Our 'Sails' systems are equally attractive and functional for shade cover over spectator seating areas, picnic courts, outdoor amphitheaters, sports fields, concessions, or any other outdoor gathering area where protection is needed from the sun's harmful U.V. rays for children and adults.



02 SEATING & CONCESSIONS



03

01 Silver Grey and Navy Blue canopies • Jet Black frame  
02-03 Desert Sand and Eggshell White canopies • Custom 'Burnt Red' frame (optional color)



Riverside Park • Grants Pass, Oregon  
Brick Red canopy • Jet Black frame

Shade Systems™ is proud to have designed and manufactured a custom Multi-Level 'Sail' shade for the City of Grants Pass, Oregon. The imaginatively layered fabric canopies provide a shaded viewing area at Riverside Park along the beautiful Rogue River.

City staff wanted a fabric shade system that would provide sun protection, but also blend well with the natural beauty of Riverside Park. To meet the City's needs, the Shade Systems team designed 2,784 square feet of shade protection using alternating layers of canopies typical of its Multi-Level 'Sail' designs. The Brick Red CoolNet™ fabrics used blend seamlessly with the changing of the leaves in autumn, and a highly durable Jet Black powder coat frame finish ensures long-term durability. Metal components also include electrical outlets and lighting for nighttime use.



01 SPECIAL EVENT AREAS



- 01-02 Light Blue and Desert Sand canopies • Jet Black frame
- 03 Eggshell White and Desert Sand canopies • Latte Tan frame
- 04-05 Aquatic Blue and Desert Sand canopies • Jet Black frame with optional night lighting (see page 46 for details)
- 06 Desert Sand and Rivergum Green canopies • Alpine White frame
- 07 Eggshell White and Desert Sand canopies • Evergreen frame

MULTI-LEVEL 'SAILS' ARE PERFECT FOR:

- Playgrounds
- Fitness Areas
- Pools & Waterparks
- Stages & Amphitheatres
- Seating & Concessions

03 POOLS





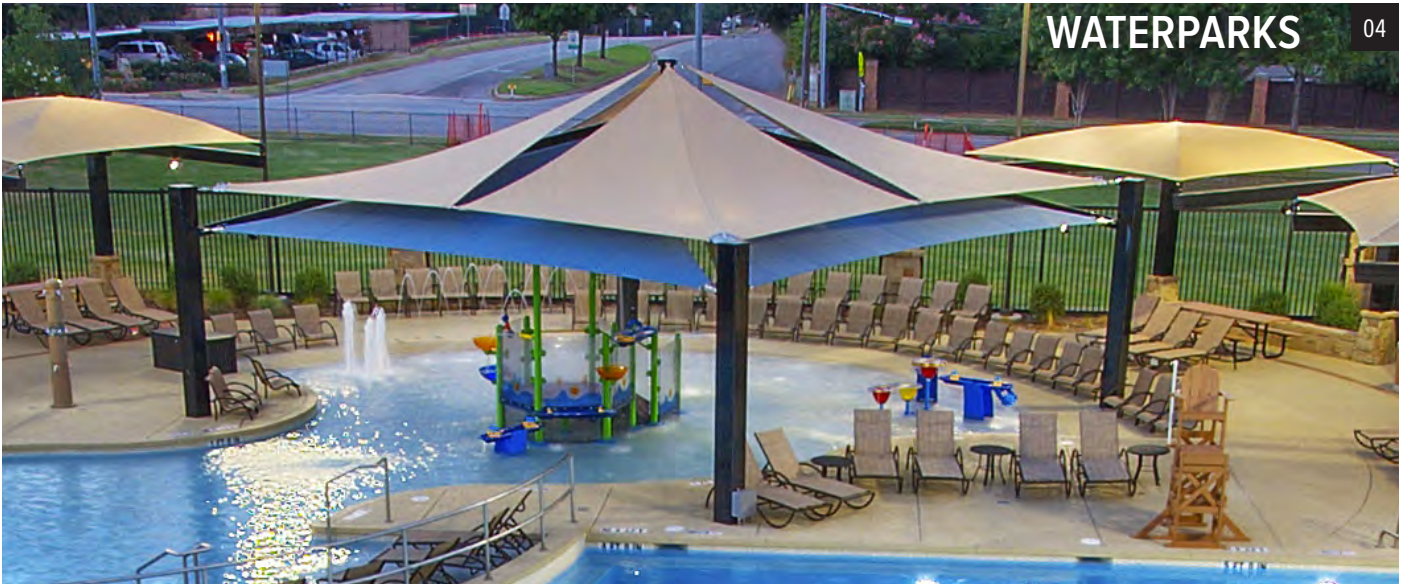

**WATERPARKS**

04

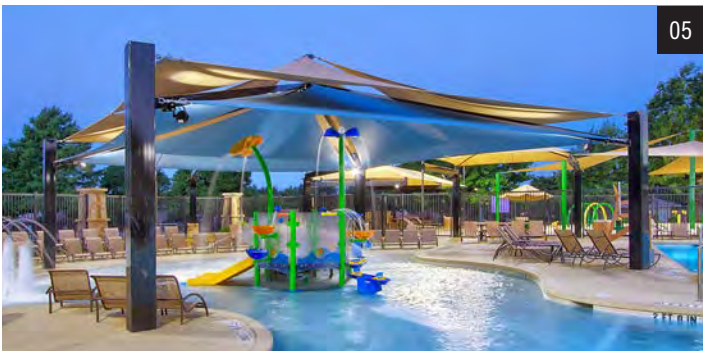

05



**PICNIC AREAS**

06



**EXERCISE COURTS**

07



# Shade Kites

Available in sizes from 15' x 15' to 30' x 30'



01

## SEATING & CONCESSIONS

### SHADE KITES ARE PERFECT FOR:

- Pool Areas
- Spraygrounds
- Playgrounds
- Seating & Concessions





02

SEATING & CONCESSIONS



03

PLAYGROUNDS



PERSPECTIVE



FRONT

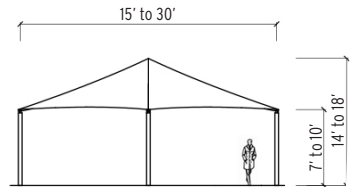

SIDE

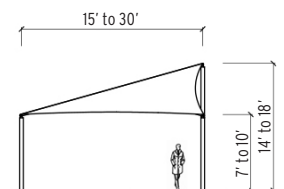

TOP

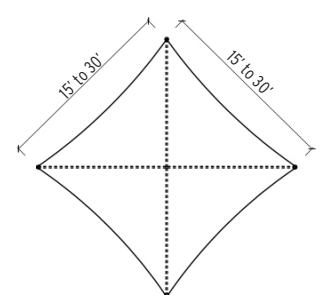

Named ‘Shade Kites’ for their soaring sky-bound shapes, these imaginative designs are a clever variation of our popular square frame-supported shades. With one corner post twice the height of the other three, Shade Kites offer the design flexibility of orienting them tilted toward the sun for maximum shading. Typical applications include poolside, by spraygrounds, or over traditional playground equipment. Shade Kites can be purchased as a single, or connected together in groups of two, three, four, or more.

Of course, Shade Kites come standard with our patented Turn-N-Slide™ easy canopy fastening and removal system. No other shade manufacturer offers the unique combination of such a shade system design with the Turn-N-Slide canopy removal and re-attachment feature built right in! Please refer to the Turn-N-Slide details on page 5.

Shade Kites are available in square sizes ranging from 15’x15’ to 30’x30’. Post heights vary from 7’/14’ to 10’/18’. All other specifications are equivalent to our regular square frame-supported shade systems.

- 01 Forest Green and Desert Sand canopies • Coffee Brown frame
- 02 Desert Sand canopy • Alpine White frame
- 03 Light Blue canopy • Alpine White frame • 30’ x 30’ x 10’/18’ eave height



# Offset Single Post Pyramid



## OFFSET SINGLE POST PYRAMID



Offset Single Post Pyramids are cleverly engineered with just one offset support column positioned to one side, thereby allowing for unobstructed circulation and efficient arrangement of seating underneath.

Our patented Turn-N-Slide™ easy canopy fastening mechanism is built right into all Offset Single Post Pyramids, making removal of the canopy for the winter season or in case of severe storm a breeze! Please refer to the Turn-N-Slide details on page 5.

All Offset Single Post Pyramids feature our remarkable CoolNet™ shade fabric in a variety of colors for maximum air cooling and protection from up to 99% of the sun's dangerous U.V. rays.

Offset Single Post Pyramids are available in sizes up to a generous 20' x 20'.



- 01 Lime Green, Aquatic Blue canopy • Latte Tan frame
- 02 Canary Yellow, Silver Grey canopy • Blue Streak frame
- 03 Desert Sand canopy • Crimson Red frame
- 04 Navy Blue canopy • Jet Black frame





## FEATURED PROJECT

Whistle Stop Park • Edgewater, Florida

Light Blue canopy • Alpine White frame • 20' x 20' x 8' eave height



Shade Systems™ is pleased to have provided four of its huge Offset Single Post Pyramid shades and one of its Mega Span playground shade covers for the fully renovated Whistle Stop Park in Edgewater, Florida – located about 50 miles northeast of Orlando.

The \$3.5 million bond-funded revitalization project at Whistle Stop Park included the Shade Systems shade canopies for the water play area, as well as one for the skate park and another for the playground. The City of Edgewater recognizes that protection of children and adults from the sun's harmful U.V. rays is essential, so the project architects specified Shade Systems products for this important site.

The City of Edgewater considers easy removability and subsequent re-attachment of the canopies an essential feature, and no system is as easy to use and well designed as the Shade Systems time-tested Turn-N-Slide™ easy canopy attachment system with 10-year warranty!





# Single Post Pyramid

SINGLE POST  
PYRAMID



Single Post Pyramids are available in 7' to 10' eave heights, and sizes ranging from 8'x8' to 20'x20'. And they feature our patented Turn-N-Slide™ easy canopy fastening mechanism built right in, making removal of the canopy for the winter season or in case of severe storm a breeze! Please refer to the Turn-N-Slide details on page 5.

Single Post Pyramids are cleverly engineered with just one central support post, making them ideal for smaller shaded areas.

## SINGLE AND DOUBLE POSTS ARE PERFECT FOR:

- Playground Seating Areas
- Picnic Areas
- Water Parks/Pool Decks
- Concessions

All Single Post shade systems feature our remarkable CoolNet™ shade fabric in a variety of colors for maximum air cooling and protection from up to 99% of the sun's dangerous U.V. rays.

Single Post Pyramids are available in sizes up to a generous 20' x20'.

# Single Post Umbrella

SINGLE POST  
UMBRELLA



Our Single Post Umbrella is available in 7' and 8' eave heights, and 16' or 20' diameter sizes. (Note: Turn-N-Slide™ not available with Umbrellas.)



# Double Post Hip

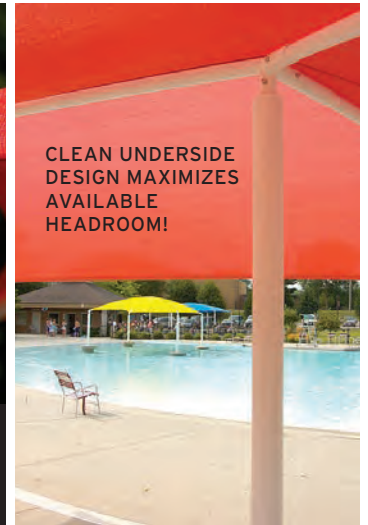
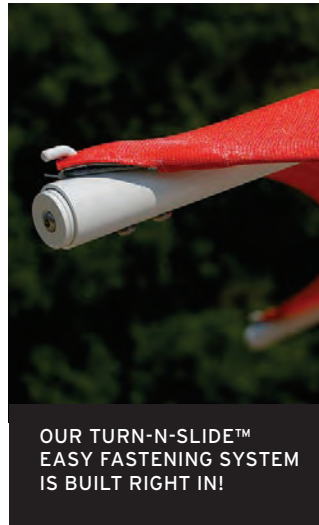

CLEAN UNDERSIDE DESIGN MAXIMIZES AVAILABLE HEADROOM!

OUR TURN-N-SLIDE™ EASY FASTENING SYSTEM IS BUILT RIGHT IN!

Our Double Post Hip is engineered to provide over 300 square feet of cooling shade with only 2 support posts. Featuring a very clean design, the Double Post Hip is perfect for poolside settings or anywhere people want to relax without worrying about dangerous exposure to the sun's U.V. rays.

DOUBLE POST HIP

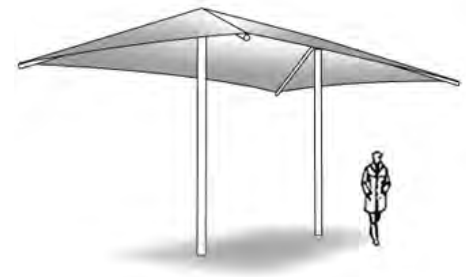

# Single Post Hypar



Our Single Post Hypar is a modern take on economical shading for small spaces with a stylish flair. Shown here with our innovative new DualNet™ shade fabric, the canopy's visual appearance creates a stunning dual color effect. Ask your Shade Systems rep about the availability of DualNet on any of our products.

- 01 Optional two-tone Eggshell White and Aquatic Blue canopies • Alpine White frame
- 02 Forest Green canopy • Evergreen frame
- 03 Bright Red, Canary Yellow, and Aquatic Blue canopies • Alpine White frame
- 04 Rivergum Green canopy • Jet Black frame
- 05 Bright Red canopy • Alpine White frame
- 06 Chameleon canopy • Alpine White frame



# Shade Walks

Available in sizes 8' x 15' and up



01 **BLEACHERS**

Ideal for applications such as walkways, dugouts, or seating, where it is desirable to keep the support posts only to one side of the shade cover, our innovative Shade Walk designs are engineered to provide maximum shade with the fewest possible post obstructions.

Available in a variety of vibrant fabric colors, the remarkable CoolNet™ canopy screens up to 99% of the sun's harmful U.V. rays, and adds architecturally pleasing color to any location. Please refer to page 48 and 49 to see fabric and metal color choices. Note that metal components are available in additional custom colors as well.

## SHADE WALKS ARE PERFECT FOR:

- Pools & Waterparks
- Bleachers and Dugouts
- Tennis and Shuffleboard
- Parking Areas
- Seating & Concessions

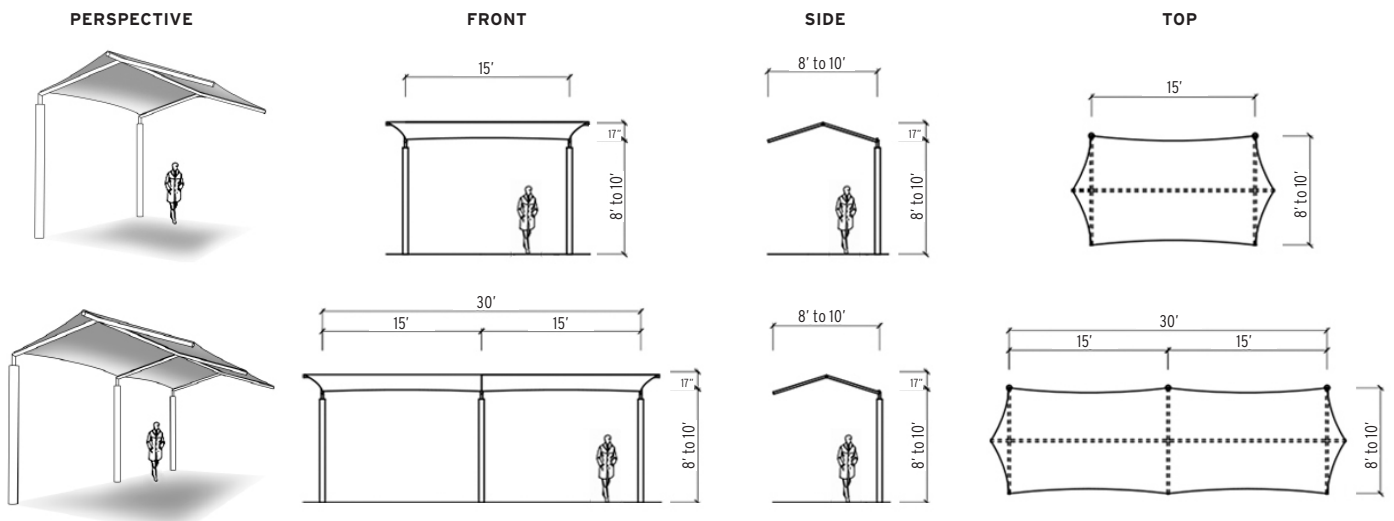





WALKWAYS

02

The Shade Walk is available in a variety of heights, lengths, and overhangs, all featuring our patented Turn-N-Slide™ easy canopy fastening system built right in! Whether it is for the winter season or an approaching hurricane, the Turn-N-Slide makes removing and re-attaching your canopy a breeze! Please refer to the Turn-N-Slide details on page 5.



POOLSIDE

03



SEATING & CONCESSIONS

04



- 01 Lime Green canopy • Alpine White frame
- 02 Aquatic Blue canopy • Crimson Red frame
- 03 Aquatic Blue canopy • Jet Black frame
- 04 Forest Green canopy • Latte Tan frame



# Tornado® Shades



Shade Systems Tornadoes® Make Your Site Spectacular!

# Day & Night







The Tornado® is one of our most stunning shade structures with sculpture-like appeal across a broad spectrum of environments where shade is needed but in an aesthetically-appealing style.

Gracefully arching steel piping arms radiate outward from a curved central support column to create a 5-point tensioned shade canopy which makes a bold architectural statement about its determination to shade stylishly. Available with electrical accommodations for beautiful fabric shade structures with night lighting (see page 46 for details).

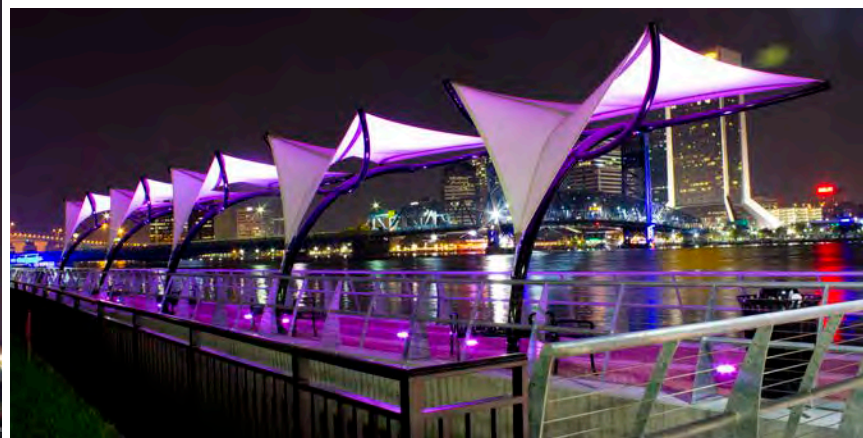



# Tornado® Shades

Available in 16' and 20' widths



01 RIVERWALKS

The Tornado® is one of our most stunning shade structures with sculpture-like appeal across a broad spectrum of environments where shade is needed but in an aesthetically appealing style.

Gracefully arching steel piping arms radiate outward from a curved central support column to create a 5-point tensioned shade canopy which makes a bold architectural statement about its determination to shade stylishly. Available with electrical accommodations for beautiful fabric shade structures with night lighting (see page 46 for details).

## TORNADO® SHADES ARE PERFECT FOR:

- Seating & Concessions
- Hotel & Resorts
- Restaurants

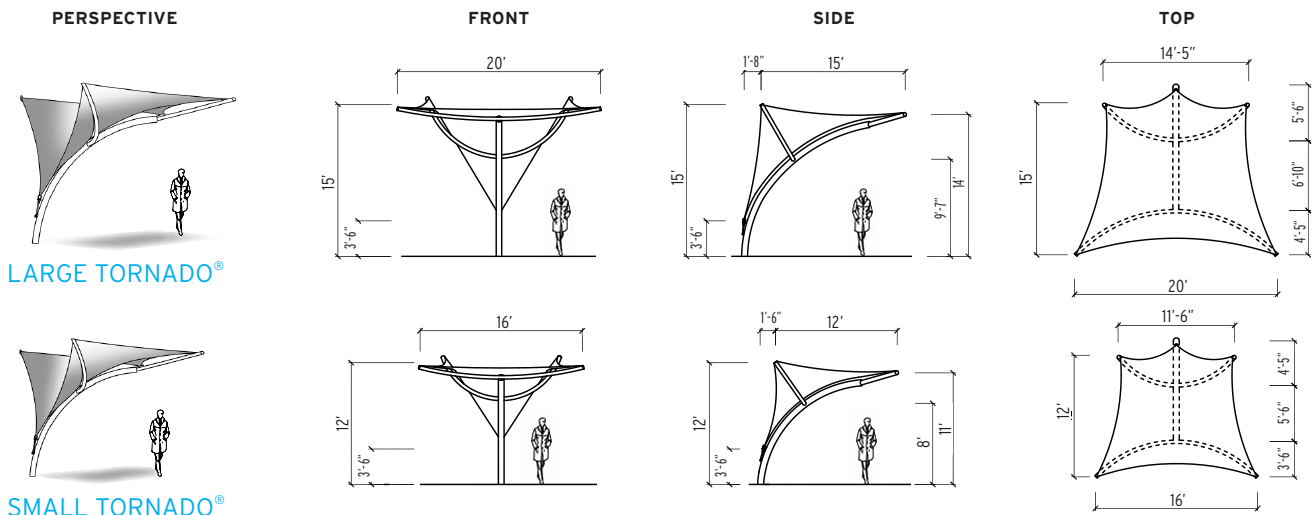





02 RESORTS



03 SCHOOLS



AVAILABLE WITH **NIGHT LIGHTING**  
(SEE PAGE 46 FOR DETAILS)

04 RESTAURANTS

Of course, The Tornado® features our remarkable CoolNet™ shade fabric in a variety of colors for maximum air cooling and protection from up to 99% of the sun's dangerous U.V. rays. Plus, removal and re-attachment of the canopy is a breeze with our simple stainless steel fastening features built right in!



- 01 Eggshell White canopy • Blue Streak frame
- 02 Eggshell White canopy • Jet Black frame

- 03 Desert Sand canopy • Blue Streak frame
- 04 Eggshell White canopy • Blue Streak frame



# Parking and Vehicle Protection



Shade Systems canopies are perfect for car parking applications as our remarkable CoolNet™ shade fabric keeps automotive interiors comfortably cool. The temperature in an unshaded car under the summer sun can rise to over 150 degrees, but a shaded car's interior temperature can be 60 degrees lower! Our canopies can also protect vehicles from costly hail damage.

Popular designs for car parking include our Mega Spans and Cantilevers. Our patented Turn-N-Slide™ easy fastening system comes standard, making Shade Systems products the most user-friendly shade structures on the market when it comes time to remove the canopies! Please refer to the Turn-N-Slide details on page 5.

And all this convenience and quality is backed up by the most comprehensive warranty coverages in the industry: 20 years against rust-through corrosion on structural steel members, 10 years against deterioration on CoolNet shade fabrics and thread, and an additional 10 year warranty on the Turn-N-Slide easy fastening mechanism and stainless steel cables.

Call Shade Systems today for our separate parking brochure and more information on how we can help you provide car parking shade that looks good, protects vehicles, and is designed to last.







SHADE SYSTEMS PRODUCTS ARE ENGINEERED FOR DURABILITY

Here are just a few of our rigorous specification highlights, with more information shown starting on page 50:

- All stainless steel hardware and cables for maximum corrosion resistance
- All metal components feature our proprietary in-house pre-treatments and powder-coat finishes for maximum adhesion and colorfastness
- CoolNet™ shade fabric canopies are the heaviest of their kind and lock-stitched for strength



- 01-03 Desert Sand canopy • Alpine White frame • Total shade coverage: Approx. 180,000 s.f.
- 04-05 Light Blue canopy • Alpine White frame • Total shade coverage: Approx. 115,000 s.f.
- 06-08 Silver Grey canopy • Jet Black frame
- 09 Turn-N-Slide™ system for easy canopy removal! See details on page 5.





01 RIVERWALKS



02 EVENING SPORTS

# Night Lighting

NIGHT LIGHTING IS PERFECT FOR:

- Boardwalks and Riverwalks
- Restaurants and Resorts
- Parking Areas
- Event and Gathering Areas
- Evening Sports

03 BOARDWALKS

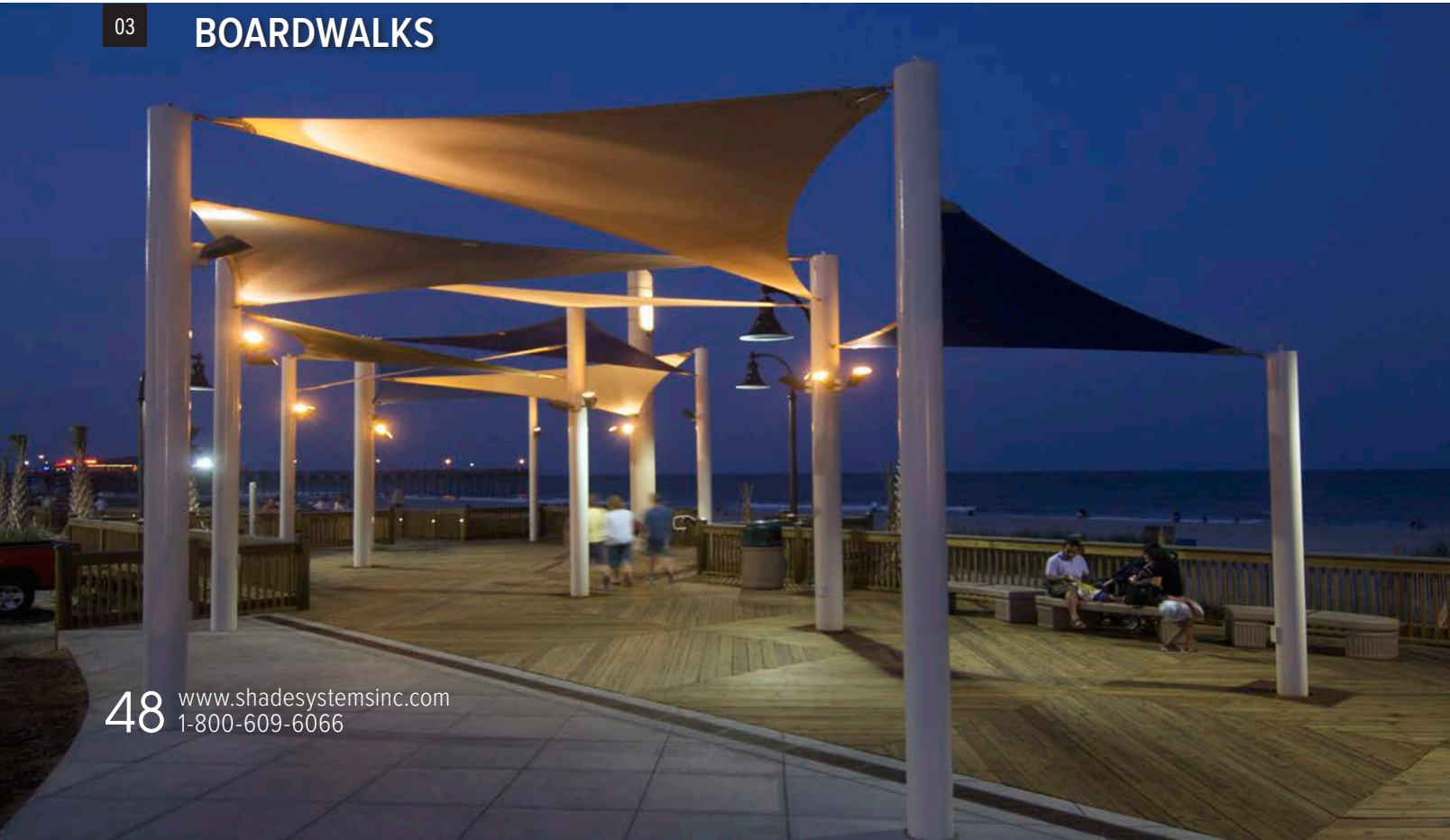





04

## POOLSIDE

Shade Systems fabric canopies and structures are available with night lighting options custom designed into steel columns or rafters for easy access to wiring.

The same shade canopies used to protect visitors from the sun's harmful U.V. rays during the day can also light and secure areas for night time games, create inviting environments for evening strolls along a boardwalk, illuminate gathering areas for events, or provide safety and high visibility in parking areas.

- 01 Eggshell White canopy · Jet Black frame
- 02 Light Blue canopy · Coffee Brown frame
- 03 Navy Blue, Aquatic Blue, Desert Sand, and Eggshell White canopies · Alpine White columns

- 04 Aquatic Blue and Desert Sand canopies · Jet Black frame
- 05 Night lighting options custom designed into steel columns or rafters for easy access to wiring (lighting fixtures by others)
- 06 Eggshell White canopy · Blue Streak frame



05

06

## RESTAURANTS





# Coolnet™ Canopy Fabric Colors



CoolNet™ has been specifically developed as a very strong and durable U.V. protection fabric for use with Shade Systems™ outdoor structures. Our canopy fabrics combine maximum sun protection with strength and durability to ensure maintenance-free exterior performance.

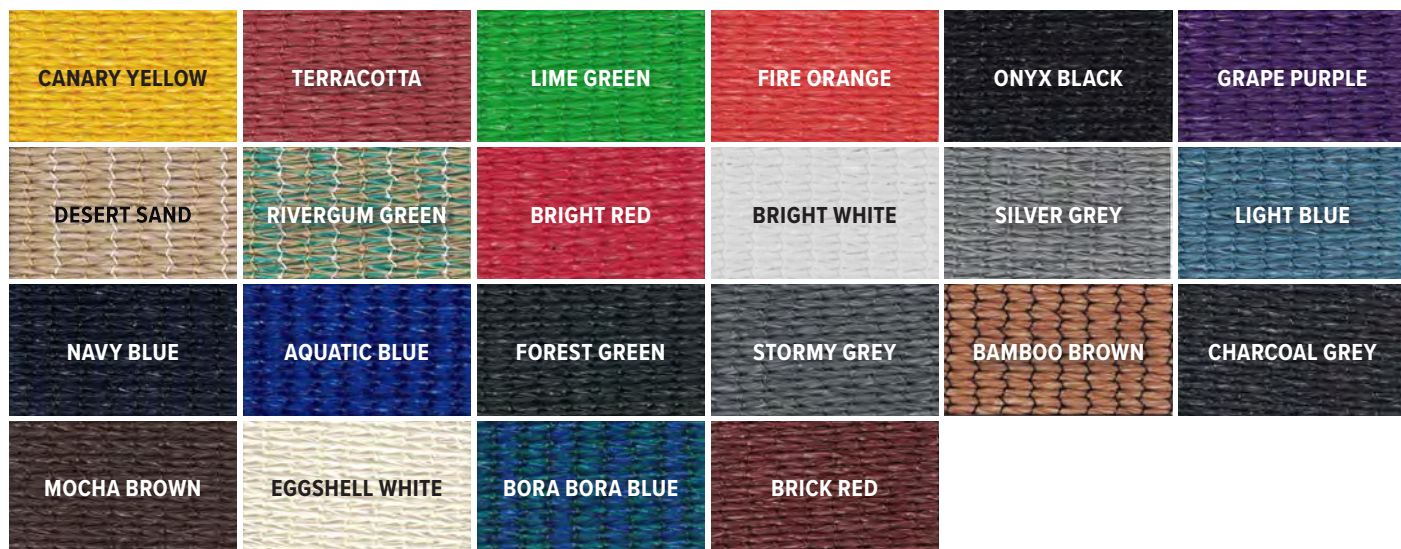

Color	Weight		% Shade Factor (Approx)	% UVR Block (Approx)
	(g/m <sup>2</sup> )	(oz./s.f.)		
Canary Yellow	340	1.11	78	93
Terracotta	340	1.11	87	93
Lime Green	340	1.11	88	91
Fire Orange	340	1.11	81	92
Onyx Black	340	1.11	95	95
Grape Purple	340	1.11	88	91
Desert Sand	340	1.11	86	93
Rivergum Green	340	1.11	90	94
Bright Red	340	1.11	80	90
Bright White	340	1.11	77	95
Silver Grey	340	1.11	90	92

Color	Weight		% Shade Factor (Approx)	% UVR Block (Approx)
	(g/m <sup>2</sup> )	(oz./s.f.)		
Light Blue	340	1.11	91	94
Navy Blue	340	1.11	93	94
Aquatic Blue	340	1.11	88	92
Forest Green	340	1.11	93	94
Stormy Grey	340	1.11	95	97
Bamboo Brown	340	1.11	88	94
Charcoal Grey	340	1.11	94	94
Mocha Brown	340	1.11	94	96
Eggshell White	340	1.11	78	94
Bora Bora Blue	340	1.11	90	93
Brick Red	340	1.11	91	92

## BASE MATERIAL

High-density polyethylene (HDPE), UV-stabilized.

## CONSTRUCTION

Monofilament and tape knitted lock stitch construction producing a fabric that will not tear or fray if cut.

## WARRANTY

10 year fabric warranty against UV degradation.



# Posts Pads



Shade Systems' protective padding is ideal for cushioning accidental bumps by young and old against our steel posts. Available in a variety of colors to match our standard powder-coat colors and sizes to fit all our structural posts, pads consist of exterior grade foam filler encased in high-gloss easy-to-clean flame-retardant vinyl. All pads are 6' high and fastened to posts with heavy-duty all weather plastic zippers.



# Metal Powder-Coat Colors

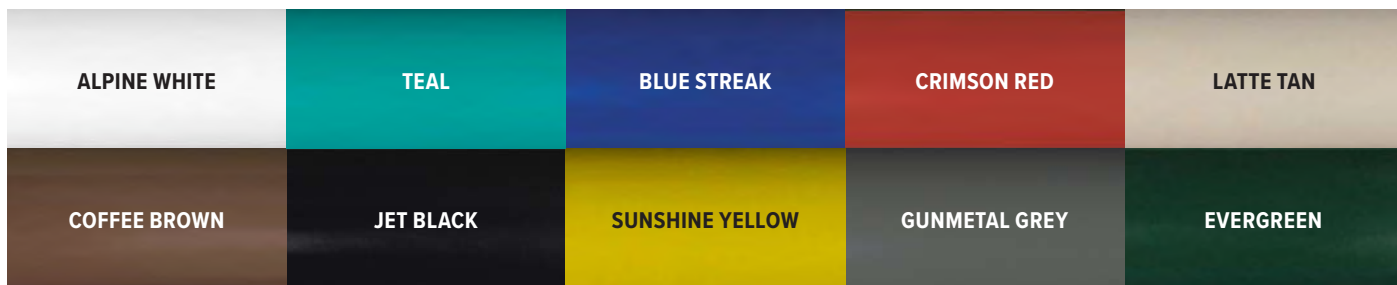

All steel tubing components are manufactured with a bright and durable polyester powder-coated finish. Standard powder-coat colors are shown above, with many optional custom colors available upon request.

PPG Envirocron™ Ultradurable powder coatings are used to provide a combination of excellent physical and chemical resistance properties, outstanding resistance to outdoor weathering, and a durable and uniform final coat.

Actual canopy fabric and metal colors may vary from representations shown on these pages.

Sample canopy fabric swatches and metal color chips are available upon request.



# Specifications & Warranty

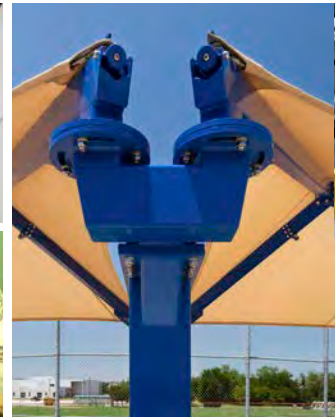

**GENERAL:** Shade Systems™ products are designed and manufactured to the most exacting specifications by skilled craftsmen, and certified by Professional Engineers for structural soundness of designs. All Shade Systems products are shipped knocked-down, with complete assembly instructions, and ready for easy in-field installation.

**MATERIAL:** All materials shall be structurally sound and appropriate for safe use. Product durability shall be ensured by the use of corrosion-resistant metals such as stainless steel, and coatings such as zinc-plating, galvanizing, and powder-coating on steel parts. Fabrics used shall be treated with UV-stabilizers for longevity, and flame retardants for safety.

**WELDMENTS:** All tubing members are factory-welded by Certified Welders to American Welding Society (AWS) specifications and to the highest standards of quality workmanship. Weldments are finished with a zinc-rich galvanized coating. No field welding is required in the assembly of Shade Systems products.

**POSTS, STRUCTURAL FRAME TUBING, AND HARDWARE:**  
All tubing used shall be cold-formed and milled per ASTM A-135 and ASTM A-500. Material testing is in accordance with ASTM E-8. Minimum yield is 40,000 psi with a minimum tensile strength of 45,000 psi on all posts.

All pre-galvanized tubing shall be pre-cut to appropriate lengths, and all outside surfaces shall be galvanized, with an interior corrosion-resistant zinc-rich coating. Where required for larger size structures, tubing and support pipes shall be black steel. All fastening hardware shall be stainless steel.

**POLYESTER POWDER COATING PROCESS:** Entails a 7-step process where all metal parts are sandblasted, mechanically smoothed, completely cleaned including using a liquid detergent iron phosphate, surfaces sealed using a reactive non-chrome sealer, coastal primer applied, and finally PPG Envirocron™ Ultradurable powder coatings applied to provide a combination of excellent physical and chemical resistance properties, outstanding resistance to outdoor weathering, and a durable and uniform final color finish. Colors shall be specified. Please refer to separate specifications for additional details.

**FOOTING DESIGNS:** Footings shall be designed per stringent International Building Code (IBC) for the specific structure. Columns will be provided as standard direct embedment or optional pier mount (anchoring hardware not supplied by Shade Systems). Other footing methods are available upon request.

*NOTE: Recommended footing dimensions vary by structure size, height, and local soil conditions. Rebar shown not included.*

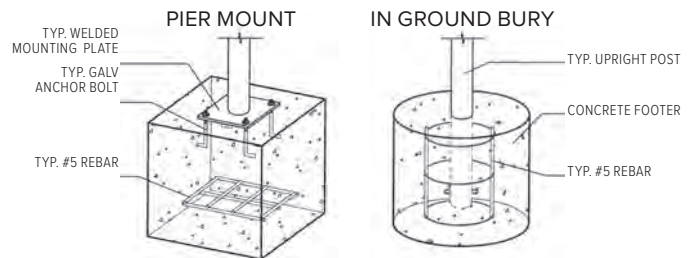

**ROOFING:**  
Structural frames are designed by Shade Systems for use only with CoolNet™ polyethylene knitted shade fabric canopy. Canopy is attached to frame using vinyl covered minimum 1/4" diameter stainless steel cables, pre-cut to fixed lengths with ends looped at the factory and pre-inserted into canopy hems. A separate cable is provided for each side of the structure for precision tensioning and ease of installation. Cable fasteners are zinc-plated copper for maximum corrosion resistance. Continuous one-piece cables, cables which are not independent per side and pre-looped and clamped at the factory, and/or cables which must be tensioned with the use of turnbuckles, come alongs, or tools not provided by the manufacturer are not acceptable.

**ENGINEERING DATA:**  
Structures are engineered to meet or exceed the International Building Code (IBC) and the following specifications:

- Wind speed: 150 m.p.h. (Frame only)  
90 m.p.h. (Frame w/canopy)
- Live Load: None
- Snow Load: None

*Above reflect standard engineering specifications, with optional higher wind speeds, live loads, and snow loads available upon request.*





**TURN-N-SLIDE™ EASY FASTENING SYSTEM:**

(U.S. Patent No. 6,814,094): Each Shade Systems frame-supported product shall include the Turn-N-Slide™ easy fastening system at ALL rafter corners. This device consists of an adjustable sleeve with welded hook and concealed internal tensioning mechanism which makes attachment, removal, and re-attachment of the CoolNet™ fabric canopy fast and easy. In case of inclement weather, winter snow, or other condition which necessitates removal and later re-attachment of the CoolNet fabric canopy, the Turn-N-Slide is used to relax the cables holding the CoolNet fabric canopy in place, facilitating removal and storage of the canopy. When the canopy is re-attached to the Turn-N-Slide hooks via its cables, they are tensioned by turning the concealed fastening mechanism in the rafter. Access to the mechanism is restricted by use of a machined aluminum cap cover secured with stainless steel vandal-resistant hex-pinned hardware. A special vandal-resistant wrench is provided to the customer with each frame-supported product for accessing the Turn-N-Slide as well as an instructional video on electronic media.

**‘SAILS’ FASTENING SYSTEM:**

CoolNet shade fabric shall be delivered complete with fastening system pre-installed. Fastening system to consist of factory-formed stainless steel tensioning plates pre-attached to fabric canopies at each corner, and cables per the above hemmed into the fabric at the factory and terminating in the bracket. Posts shall be equipped with an adjustable 360-degree swivel and pivot attachment mechanism to which the tensioning plate fastens. Tensioning plate includes a stainless steel adjustment bolt which, when turned, tensions the fabric for a taut fit. Fabrics, cables, and brackets which are not pre-assembled at the factory are not acceptable. Cables which attach to posts with u-bolts or ‘S’ hooks, and which do not use a stainless steel bracketing system similar to the above are not acceptable.

**COOLNET™ SHADE FABRIC:**

Knitted of monofilament and tape construction high density polyethylene with Ultra Violet (U.V.) stabilizers and flame retardant. UV-Block Factor varies by standard color offered from 91% to 99.1%.

**Flammability:**

CoolNet™ shade fabrics is treated with fire retardants, and meet the most stringent Fire Standards for shade fabrics including CSFM 1237.1 and NFPA 701 across all color variants.



Nominal Thickness:	0.057 inches
Fabric Mass:	Min 340 g/m2
Light Fastness:	7-8 (Blue Wool Scale)
Weather Fastness:	4-5 (Grey Scale Test)
Tear Resistance:	Warp 210N • Weft 276N
Breaking Force:	Warp 786N • Weft 2494N
Bursting Pressure:	Mean 3500kPa
Bursting Force:	Mean 2146N

*All hems and seams are double row lock stitched using exterior grade UV-stabilized polyethylene GORE™ TENARA® sewing thread (GORE™ and TENARA® are trademarks of W. L. Gore & Associates).*

**WARRANTY INFORMATION:**

Shade Systems, Inc. warrants that the equipment sold will conform in kind and quality to the specifications listed in the Order Acknowledgment and will be free of defects in workmanship or materials. Shade Systems further warrants:

- LIMITED 20 YEAR WARRANTY:** on all upright posts and support structure frames against failure due to rust-through corrosion.
- LIMITED 10 YEAR WARRANTY:** on all CoolNet™ fabrics and stitching thread against degradation, cracking or material breakdown resulting from ultra-violet exposure, as well as on Turn-N-Slide fastening device and stainless steel cables. This warranty excludes failure of fabric or threads due to chemical erosion, and also excludes post pads.
- LIMITED 1 YEAR WARRANTY:** for failure of any other product or part not covered by one of the above warranties.

*All above warranties commence on the date of the Seller's invoice. Please ask for a copy of our complete Limited Warranty for additional details, limitations, and other important warranty information, or go to [www.shadesystemsinc.com](http://www.shadesystemsinc.com).*

**TERMS & CONDITIONS:**

- Pricing:** Prices do not include delivery and installation charges and are subject to change without notice.
- Terms:** To tax supported institutions and those with established credit, Net 30 days from date of invoice, 1.5% per month thereafter; freight charges are prepaid and added to invoice.
- To all others: payment in advance.
- Taxes:** Prices shown do not include any applicable taxes.
- Delivery:** Delivery of products is by common carrier, with truck unloading the responsibility of the customer. Should there be damages or shortages, notify carrier at once and sign the delivery receipt noting the damages or shortages. Should it be necessary, we offer the service of filing freight claims for customers. We will need the original freight bill showing the shortage or damage and the signature of the driver.

*Due to continuous product development and improvement, Shade Systems reserves the right to change specifications contained herein at any time without notice.*



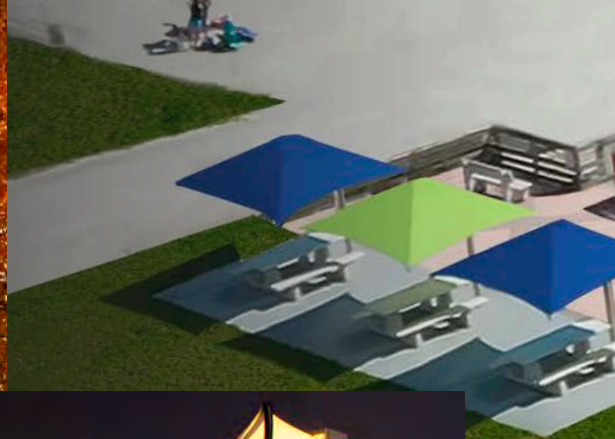
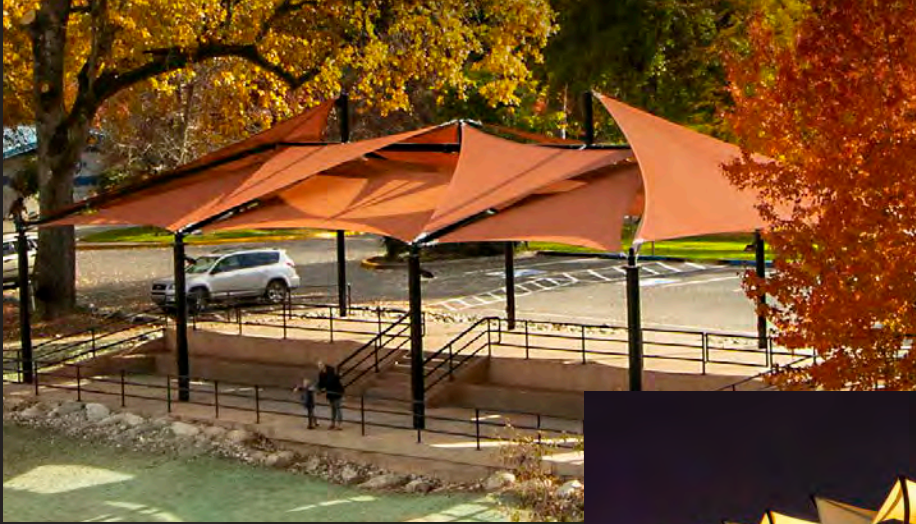

See page 28 for MULTI-LEVEL 'SAILS'



See page 40 for TORNADO® Shades



See page 14 for WRAPAROUND SINGLE CANTILEVERS

See page 06 for MEGA SPANS



See page 20 for ARC CANTILEVERS



Shade Systems, Inc.  
4150 S.W. 19th Street  
Ocala, Florida 34474

Toll Free: 1-800-609-6066  
Local: 352-237-0135  
Fax: 352-237-2256

Email: [info@shadesystemsinc.com](mailto:info@shadesystemsinc.com)  
Web: [www.shadesystemsinc.com](http://www.shadesystemsinc.com)

© 2021 Shade Systems Inc. All rights reserved.

